

SolarEdge Residential Offering for Installers



solar**edge**

Content

04	SolarEdge Fact Sheet
06	The Complete SolarEdge Residential Solution
08	More Energy from Each Panel
10	Superior Safety
12	Design Flexibility
13	Peace of Mind
14	Single Phase Inverters with HD-Wave Technology
15	Three Phase Inverters for Residential Installations
16	EV Charging Single Phase Inverter
18	Single Phase Inverters with Compact Technology
19	The New Standard in Inverter Commissioning
20	Full Monitoring of PV and StorEdge Systems
21	Monitor Home Consumption with a SolarEdge Energy Meter
22	The StorEdge Solution: Enabling Energy Independence
24	Maximising the Homeowner's Solar Investment with StorEdge
26	Basic StorEdge DC-Coupled Applications
28	Advanced StorEdge Configurations
30	StorEdge Case Study: Increasing Self-Consumption
32	Smart Energy Products
34	Export Limitation Solution
36	Faster, Easier PV System Design
37	Working with SolarEdge
38	Residential Product Offering
40	SolarEdge Ordering Information

SolarEdge Fact Sheet

About Us

In 2006, SolarEdge invented an intelligent inverter solution that has changed the way power is harvested and managed in PV systems. Today, we are a global leader in smart energy technology. By deploying world-class engineering capabilities and with a relentless focus on innovation, we create smart energy products and solutions that power our lives and drive future progress.

Vision

We believe that continuous improvement in the ways we produce and consume energy will lead to a better future for us all



Bankability

- Approved by major banks and financial institutions worldwide
- SolarEdge (SEDG) is traded on NASDAQ
- Our financial strength and stability, combined with our cutting-edge technology, has propelled us to become one of the largest residential inverter manufacturers in the world

Global Reach

- Systems installed in over 130 countries across five continents
- Sales via leading integrators and distributors
- Follow the sun call centers
- Local teams of sales, service, marketing, and training experts
- Global manufacturing capabilities with tier 1 electronic manufacturing service companies



Received nearly 30 awards from prestigious organisations including Red Herring, Frost & Sullivan, Intersolar, the Stratus Award, and the Edison Awards™

Shipping Since 2010

- Over 1.5 million inverters shipped worldwide
- SolarEdge's monitoring platform continuously tracks hundreds of thousands of installations across the globe

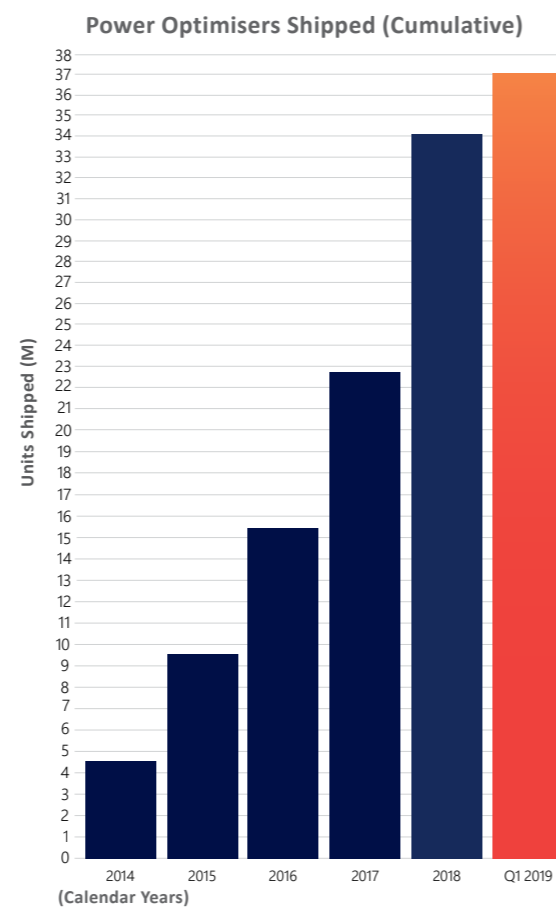

Corporate Social Responsibility

- As an industry leader in renewable energy technologies, SolarEdge strives to limit the harmful effects of traditional energy sources by promoting the spread of clean, sustainable energy around the world
- SolarEdge is in full compliance with international standards on quality and control, ethical conduct and environmental protection



Patents

SolarEdge has a vast portfolio of intellectual property, with hundreds of awarded patents and patent applications

Product Reliability

- 25-year power optimiser warranty and 7-year inverter warranty, extendable to 25 years
- SolarEdge products and components undergo rigorous testing, and have been evaluated in accelerated life chambers
- Reliability strategy includes proprietary application specific ICs (ASIC)

The Complete SolarEdge Residential Solution

Smart Energy

- Utilise excess solar energy to power heat pumps, to heat water, or to power lights and other home appliances
- Automatic, on-the-go control of smart devices via SolarEdge's monitoring platform

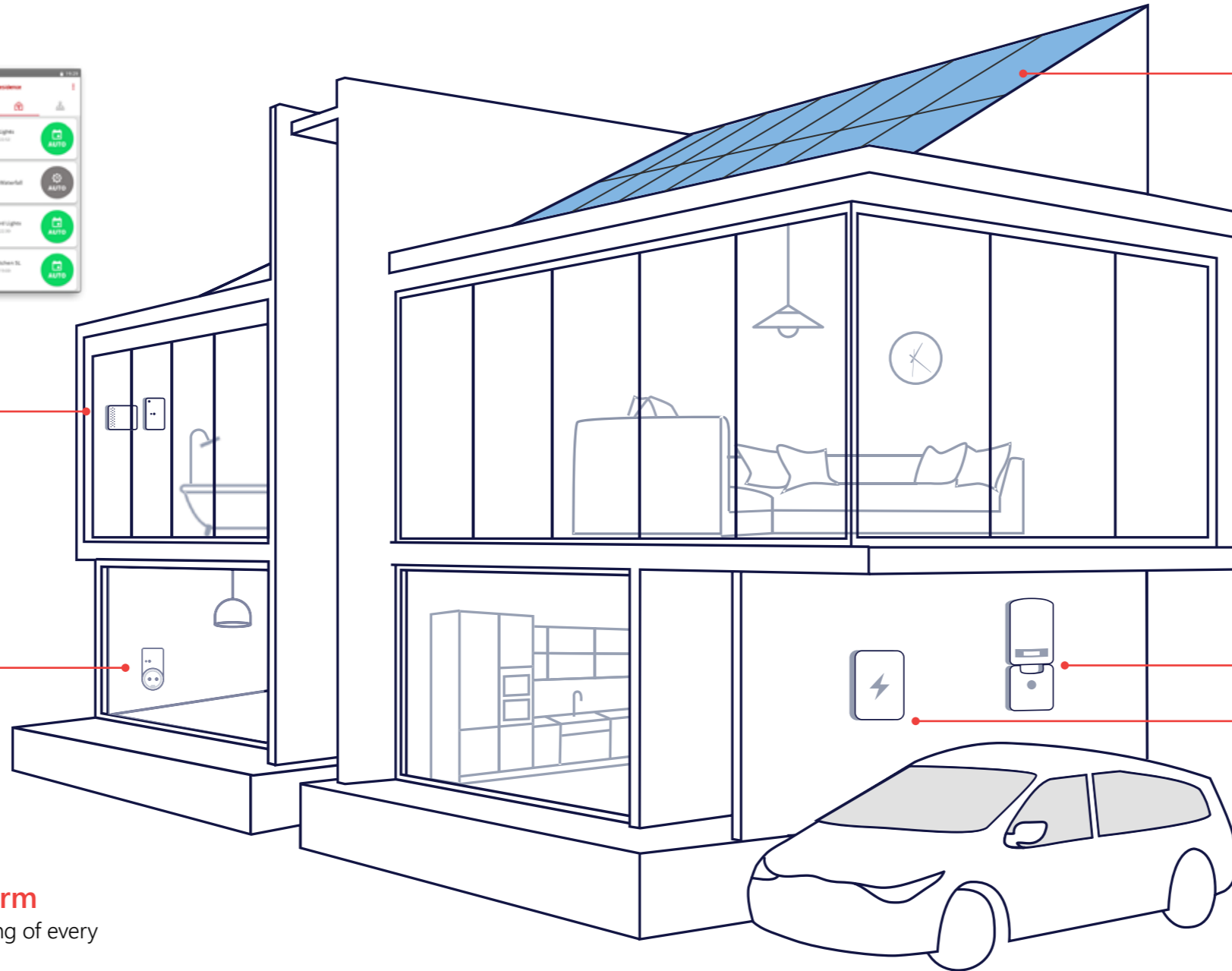
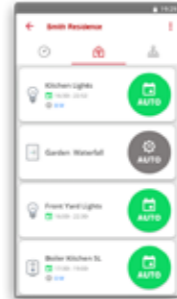

Power Optimiser

- Connects to each solar panel on the roof to maximise their individual performance
- Provides greater energy production, enhanced safety, and constant information from each panel



Inverter

- The brains of the PV system
- Efficiently converts DC energy to AC electricity for use in the home and utility grid
- Manages system production, battery power, EV charging, and smart energy

Monitoring Platform

- Free real-time monitoring of every system panel
- Monitoring of PV production, consumption and self-consumption, smart energy, as well as battery and EV charging levels
- Automatic alerts
- Access from your mobile device, anytime, anywhere



StorEdge®

- Store unused PV energy in batteries for times when solar energy is not available
- Provides backup power for the home during grid outages



Compatible with

 LG Chem RESU 7H/10H batteries

More Energy from Each Panel

In a PV system, each panel has an individual maximum power point. Differences between panels are unavoidable in PV installations. With traditional inverters, the weakest panel reduces the performance of all panels.

With SolarEdge, each panel produces the maximum energy, and mismatch-related power losses are eliminated.

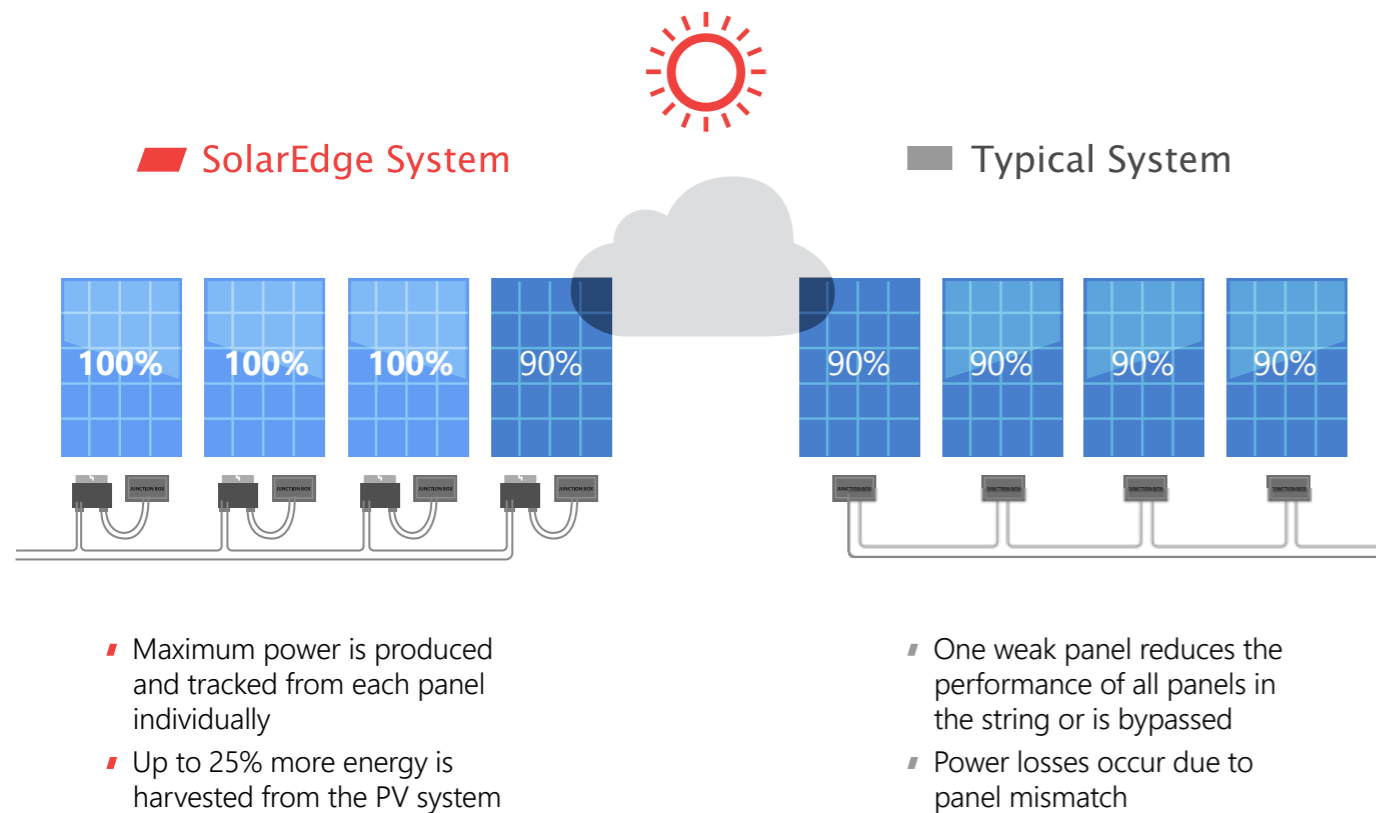

Homeowner Value: More Energy

More power = more revenue and more savings on your electricity bill. One underperforming solar panel connected to a traditional string inverter negatively impacts the performance of an entire string. SolarEdge minimises this issue by allowing each panel to perform to the best of its ability at all times.

Power losses can result from:

Manufacturing Tolerance Mismatch

The warranted output power range for PV panels received from a manufacturing plant may vary greatly. A standard deviation of $\pm 3\%$ is sufficient to result in $\sim 2\%$ energy loss.



Guaranteed power output from panel manufacturers 0~+3%

Soiling, Shading and Leaves

Panel soiling, from dirt or bird droppings, contribute to mismatch between panels and strings. While there may be no obstructions during site design, throughout a residential system's lifetime, a tree may grow or a structure may be erected that creates uneven shading.

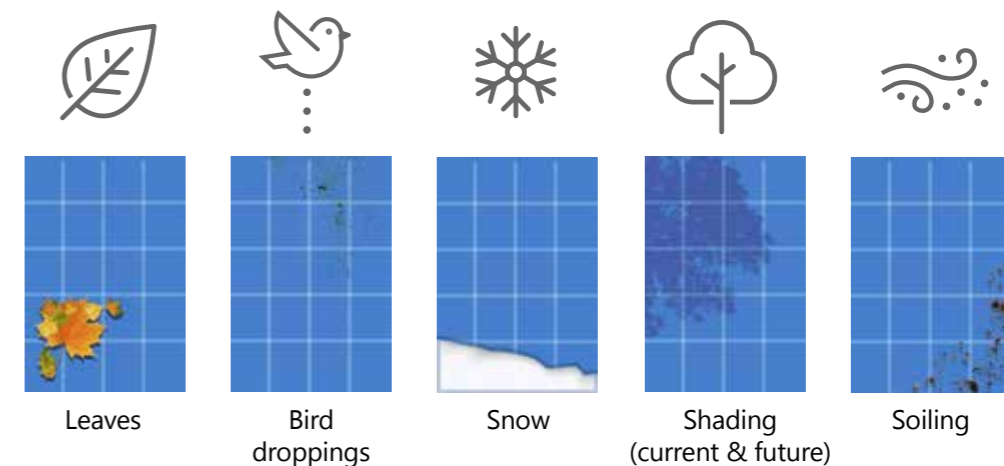

Uneven Panel Aging

Panel performance can degrade up to 20% over 20 years, however, each panel ages at a different rate, causing aging mismatch, which increases over time.

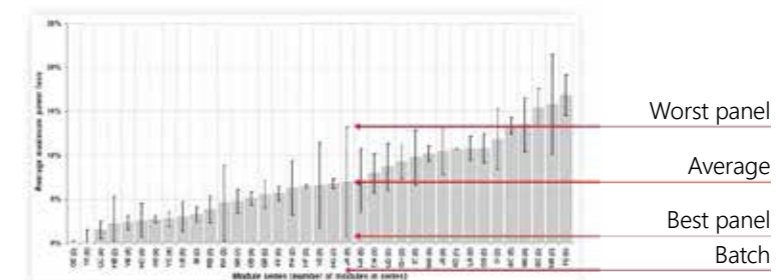

Source: A. Skoczek et. al., "The results of performance measurements of field-aged c-Si photovoltaic modules", Prog. Photovolt: Res. Appl. 2009; 17:227-240

Inverter voltage < 30v



Superior Safety

With millions of photovoltaic (PV) systems installed worldwide, this technology is designed to be relatively safe and reliable. However, as traditional PV installations can reach voltages as high as 1,500VDC, precautions should be taken to ensure the safety of people and assets.

With traditional inverters, shutting down the inverter or the grid connection will terminate current flow, but DC voltage in the string cables will stay high for as long as the sun is shining.

In addition, electrical arcs, which can result in a fire, create a threat to people and assets in the vicinity of the PV system.

The SolarEdge system provides a superior safety solution for both electrocution and fire risks.

SafeDC™

SafeDC™ is a built-in panel-level safety feature which minimises electrocution risk. To maintain string voltage below risk levels, power optimisers are designed to automatically switch into safety mode, in which the output voltage of each panel will be reduced to 1V in either of these cases:

- During installation, when string is disconnected from the inverter, or the inverter is turned off
- During maintenance or emergency, when the inverter or AC connection is shut down
- When the thermal sensors of the power optimisers detect a temperature above 85 °C



The SolarEdge SafeDC™ feature is certified in Europe as a DC disconnect according to IEC/EN 60947-1 and IEC/EN 60947-3 and to the safety standards VDE AR 2100-712 and OVE R-11-1.

Arc Fault Detection and Interruption

SolarEdge inverters have a built-in protection designed to mitigate the effects of some arcing faults that may pose a risk of fire, in compliance with the UL1699B arc detection standard.

Currently there is no comparable arc detection standard in the EU and therefore non-US SolarEdge inverters can detect and interrupt arcs as defined by the UL1699B standard. In addition to manual restart, a mechanism for auto-reconnect can be enabled during system commissioning.

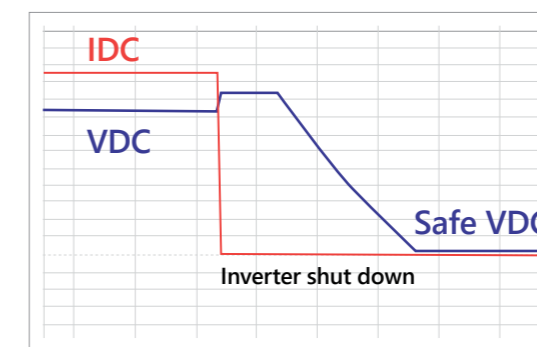

This graph represents an automatic string shutdown. As demonstrated, the current is shut down immediately once AC power or Inverter is turned off. The string voltage is reduced to safe voltage.

Homeowner Value: Superior Safety

For decades now, PV systems have proven to pose minimal safety risks. SolarEdge further improves PV safety with its SafeDC™ feature, designed to reduce your PV system's high voltage to a safe 1 volt per panel whenever the grid is shut off, protecting solar professionals, installers, firefighters and your home.

Design Flexibility

More power, more revenue, and more aesthetic rooftops

The SolarEdge system topology enables efficient use of all available roof space through unprecedented design flexibility. A wide variety of string lengths is possible with no requirement for matching string lengths. With longer strings, the installer's BoS costs are lowered. The size and layout of an array is no longer defined by electrical constraints. Shaded panels do not bring down the entire string performance, and panels power rating, bin, and type can be mixed in multiple orientations or tilts, in the same string.

With SolarEdge's optimised design flexibility, every installation can become more profitable with the ability to sell more panels at no extra customer acquisition and installation costs.

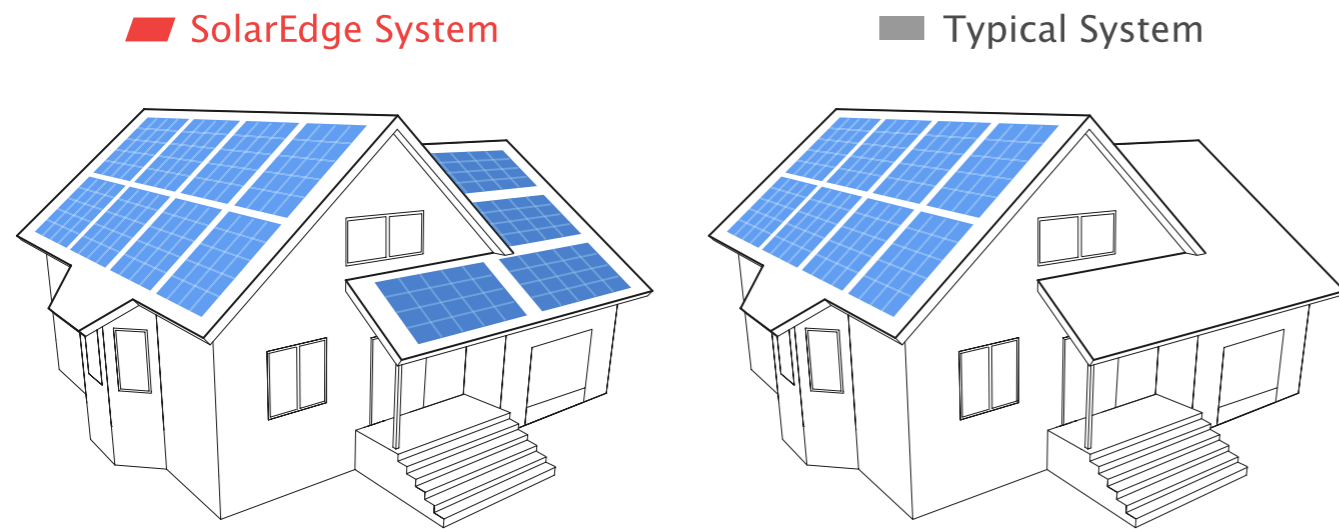

Homeowner Value: Design Flexibility

SolarEdge combines optimal rooftop usage with an aesthetic design, for more power and more savings. Mix and match panel types to easily expand your solar system later.

Peace of Mind

Panel-Level Monitoring

SolarEdge delivers free, real-time remote monitoring at the panel, string, and system levels, ensuring that the installation is performing to the best of its ability at all times. The SolarEdge monitoring platform provides comprehensive analytics tracking and reports of energy yield, system uptime, performance ratio, and financial performance. Pinpointed and automatic alerts for immediate fault detection, accurate maintenance, and rapid response result in minimal and shortened onsite visits.



It offers customisable views so that installers can share either system-level or panel-level performance. Numerous communication options exist for connecting SolarEdge inverters to the monitoring platform, via hardwired Ethernet, Wi-Fi, ZigBee® wireless, or cellular connections. Access to the monitoring platform is easily available from your computer or mobile device, anytime, anywhere.

Protecting the Homeowner's Investment

As part of residential PV design, it is important to account for future costs that can impact the return on investment of a homeowner's PV system. The SolarEdge DC optimised inverter solution effectively minimises these potential costs.

- Replacement: SolarEdge allows panels of different power classes and brands in the same string. Any panel available in the market could fit.
- Expansion: New power optimisers and panels can be utilised in the same string with older models.

SolarEdge products are built for long-term performance, with warranties of 25 years for power optimisers, 7 years for inverters, and free monitoring for 25 years. Affordable extended inverter warranties of up to 25 years are also available, with low-cost out-of-warranty inverter replacement at ~40% less than traditional inverters.



Homeowner Value: Peace of Mind

With real-time monitoring of system performance and long product warranties, SolarEdge assists you in protecting your investment and provides you with peace of mind.

Single Phase Inverters with HD-Wave Technology

A New Era for Inverter Technology

Representing one of the most significant leaps in solar technology in the past 20 years, SolarEdge's HD-Wave technology is a novel power conversion topology that significantly decreases inverter size and weight, while also achieving record 99% weighted efficiency.

Activating and configuring the inverter is now done directly through your smartphone using the SetApp mobile application.



Achieving More with Less

By employing distributed switching and advanced digital processing to synthesise a clean, high-definition sine wave, inverters with HD-Wave technology have <math><1/2</math> the heat dissipation, 16x less magnetics, and 2.5x less cooling components than previous SolarEdge inverters, which are already among the smallest on the market.

Product Features:

- Multiple sizes with 2.2kW to 6kW inverter range
- More energy from a record 99% weighted efficiency
- More panels on the rooftop with up to 155% DC/AC oversizing
- Easy installation due to small size and light weight
- Improved reliability with less heat
- Superior safety with SafeDC and arc detection
- High visibility with built-in panel-level monitoring
- Quick and easy inverter commissioning directly from your smartphone using the SolarEdge SetApp
- Backward compatibility with existing SolarEdge systems

Three Phase Inverters for Residential Installations

Making Three Phase Installations Easier



SolarEdge's next generation of low power, three phase inverters for the residential market features multiple design improvements, making it smaller, lighter and easier to install than previous models. Suitable for both outdoor and indoor installations, these inverters run quieter than before following an upgrade to the internal fan and removal of the external fan.

Activating and configuring the inverter is now done directly through your smartphone using the SetApp mobile application.

Product Features:

- Multiple inverter sizes including 4kW, 5kW, 7kW, 8kW, 9kW, and 10kW
- Easy installation due to small size and light weight
- Quiet operation designed for residential environments
- Superior safety with SafeDC and arc detection
- High visibility with built-in panel-level monitoring
- IP65-rated, suitable for indoor or outdoor installations
- Quick and easy inverter commissioning directly from your smartphone using the SolarEdge SetApp
- Internet connection via Ethernet or wireless communication (via Wi-Fi, ZigBee, or cellular connectivity)

EV Charging Single Phase Inverter

The World's First EV Charging Inverter

Increase your revenue with the world's first EV charging PV inverter. It offers users the ability to charge electric vehicles up to 2.5 times faster than a standard EV charger through an innovative solar boost mode that utilises grid and PV charging simultaneously.

By installing the EV charging inverter, your customers also benefit from the reduced hassle of installing separately a standalone EV charger and a PV inverter, as well as integration with the SolarEdge monitoring platform.

Whether your customer owns an EV now or just wants to be EV-ready, drive your business into the future with SolarEdge.

Coming Soon!



Key Benefits

- Combines sun and grid power for charging up to 2.5 times faster than standard EV chargers
- Reduces workload and costs of installing a standalone EV charger and a PV inverter
- An EV-ready solution, future-proofed for new EV purchase or replacement, and compatible with multiple EV connectors
- Maximises self-consumption by using excess PV for EV charging

- Fully integrated with the monitoring platform and easy inverter commissioning using the SetApp mobile app
- Built-in meter enables separate tracking of EV power usage for visibility and control
- 12-year warranty⁽¹⁾, extendable to 20 or 25 years
- Demand-response ready

Full Visibility and Control

The SolarEdge EV charging inverter supports full network connectivity and integrates seamlessly with the monitoring platform. Homeowners can track their charging status, control vehicle charging, and set charging schedules.

Feature highlights

- Smart-scheduling for use with Time of Use (TOU) rates — charge from the grid during off peak hours
- Track PV, EV, and grid consumption for visibility and control of household energy usage
- Remote operation via mobile app — turn charging on and off directly from your smartphone
- View charging duration, charge energy, and percent charge from PV

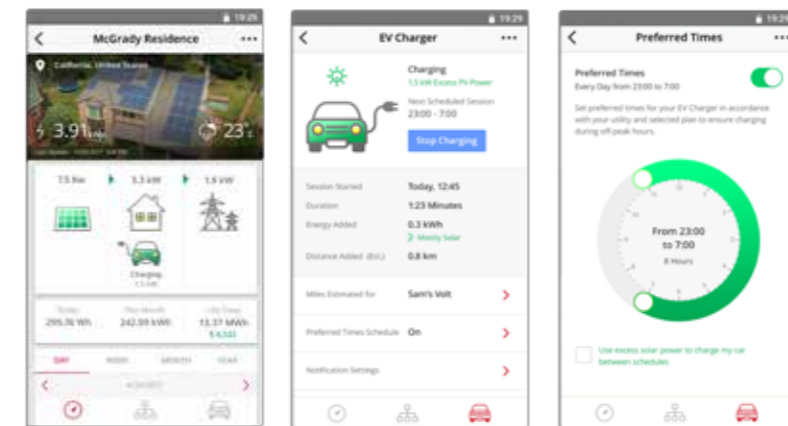

EV Charging Comparison

	Standard EV Charger (2.7 kW 12A@230Vac)	SolarEdge EV Charger Mode 3 with Solar Boost Mode Charging speed depends on PV production (Maximum 7.4kW 32A@ 230Vac) ⁽²⁾
Added kilometers per 1 hour of charging ⁽³⁾	8 to 15 kilometers	35 to 40 kilometers
Charge time for daily commute ⁽³⁾	4 to 8 hours	1 to 1.5 hours

⁽¹⁾ Cable and connector are not included
⁽²⁾ Check your car manual for maximum charge rate
⁽³⁾ Assuming 5 km/kWh and with a EU household average driving distance of 50 km per day
(sources: <https://setis.ec.europa.eu/related-jrc-activities/jrc-setis-reports/driving-and-parking-patterns-of-european-car-drivers>)

Single Phase Inverters with Compact Technology

Affordable, Green Electricity for Small Residential Rooftops

SolarEdge has developed a residential DC-optimised inverter solution, ideally suited for homes with limited roof space, social housing projects, or for meeting minimum sustainability requirements.

The single phase inverter with compact technology is packed with the standard SolarEdge benefits such as greater energy harvest from each panel, long-term product warranties, advanced safety features, and free panel-level monitoring. It is easily installed on either existing rooftops or new builds, and delivers clean energy, which is affordable, efficient, and safe.



Specifically Designed for Rooftop Systems of 4-8 Panels

- Power optimiser and inverter designed to work exclusively with each other
- Inverter is available in three sizes: 1000VA, 1500VA, and 2000VA
- Extremely compact, lightweight, and easy to install
- One or two 60-cell PV panels, or one 72/96-cell panel, can be connected to each input
- Quick and easy inverter commissioning directly from your smartphone using the SolarEdge SetApp
- IP65-rated inverter — suitable for indoor or outdoor installation
- Flexible communication options for maximum cost effectiveness, depending on project requirements
- Real-time monitoring of individual or multiple systems

The New Standard in Inverter Commissioning

Inverter commissioning has never been this easy. Activating and configuring your inverter is now done directly through your smartphone using the SetApp mobile application. All the information you need is in the palm of your hand — the display screen is no longer needed in the new range of SolarEdge inverters!

Download the SetApp mobile app for Android or iOS smartphones, and take inverter commissioning to the next level.



Faster Inverter Activation with SetApp

SetApp makes commissioning your installation quick and simple with step-by-step instructions and easy to read menus.



Connect

- Scan the inverter barcode to create a fully secure local Wi-Fi connection between your smartphone and the inverter



Update & Activate

- Always have the latest firmware version
- Saves you time on obtaining the latest version and updating the inverter
- Inverter is automatically activated



Configure

- Configure parameters such as country and grid, language, communication options
- Step-by-step instructions
- Simultaneous configuration of up to 31 additional devices from the master inverter

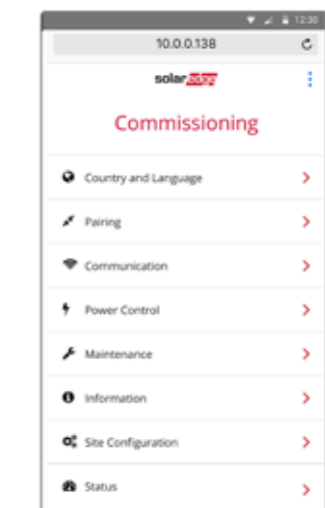

LEDs on the bottom of the inverter give you a visual status indication - signaling whether the system is producing energy, whether the inverter is communicating with the monitoring platform, and indicating any system errors.

Read more about LED functionality at: solaredge.com/leds

Full Monitoring of PV and StorEdge Systems

The SolarEdge monitoring platform provides insight into household PV production and consumption, displaying the power flow between the PV array, battery, grid and house loads as well as tracking real-time system data.

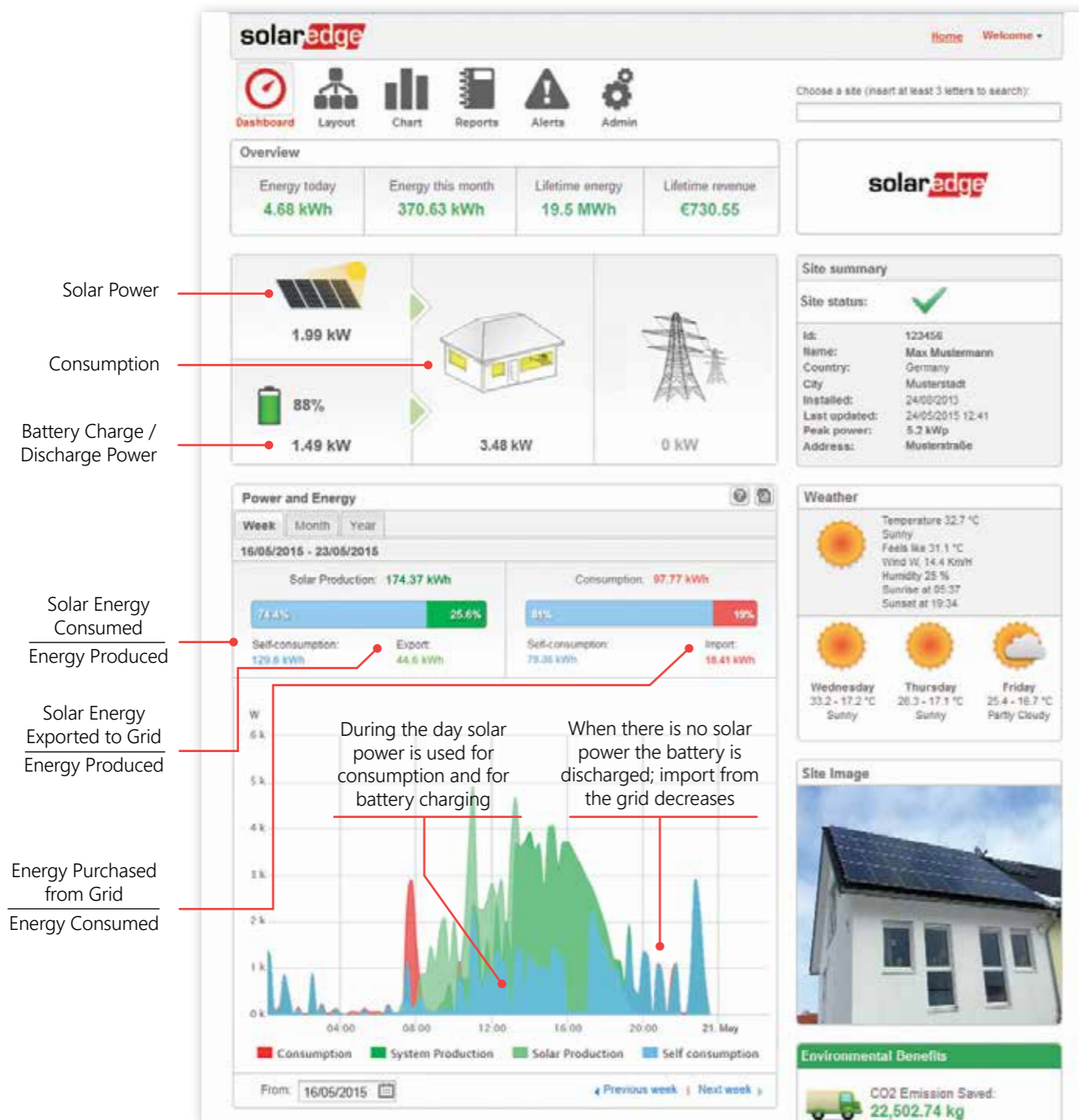

Dashboard from the SolarEdge monitoring platform

Monitor Home Consumption with a SolarEdge Energy Meter

The SolarEdge energy meter provides full insight into the electricity produced by your customer's PV system and the household consumption 24 hours a day, displayed in the SolarEdge monitoring mobile app in an easy to understand format.



Full transparency of energy consumption

By understanding how and when homeowners generate and use power, they can make more use of the energy produced by their PV system by diverting excess solar energy to other electrical appliances around the home.

Get real-time insight into home energy production and usage

Once the SolarEdge energy meter is installed, the monitoring platform can be used to view homeowners energy production and consumption levels.

The energy meter also lets you add additional energy saving products to your customer's system, either now or in the future. To maximise self-consumption, add battery storage or SolarEdge smart energy products.

The StorEdge Solution: Enabling Energy Independence

Combining SolarEdge's breakthrough PV inverter technology with leading battery storage systems, the StorEdge solution helps homeowners reduce their electricity bills while maximising energy independence from the grid.



StorEdge is based on a single SolarEdge DC optimised inverter that manages and monitors PV production, consumption and storage. StorEdge is compatible with the LG Chem RESU 7H and 10H batteries.



LG Chem RESU

Optimising Self-Consumption

The StorEdge solution can be used to increase energy independence for homeowners, by utilising a battery to store power and supply power as needed. To optimise self-consumption, the battery is automatically charged and discharged to meet consumption needs and reduce the amount of power purchased from the grid.

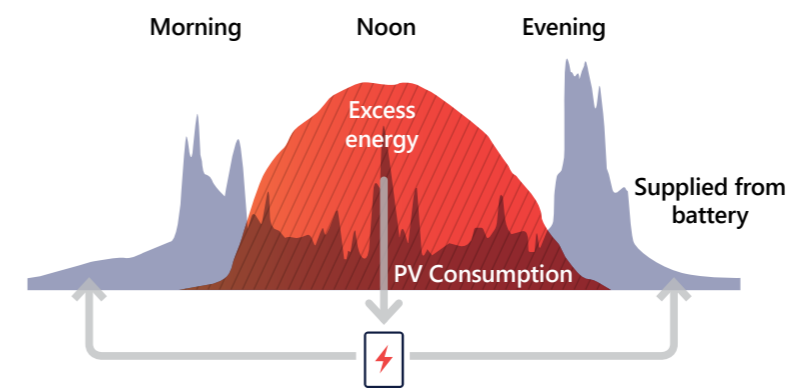

Using StorEdge, excess energy produced during peak sunlight hours when consumption is low is stored to a battery and used later. Energy isn't wasted!

Optimising Self-Consumption + Backup Power

In addition to optimising self-consumption, StorEdge can also automatically provide backup power to pre-selected loads when the household suffers from grid interruptions. A combination of PV and battery is used to power important loads such as the refrigerator, TV, lights and AC outlets, day or night.

Providing backup power day or night



Charge battery from the PV system

Daytime: Important loads are powered first by the PV system and then by the battery. The battery can be charged from the PV as needed

Nighttime: Important loads are powered by the battery

Maximising the Homeowner's Solar Investment with StorEdge

The StorEdge system is full of benefits for the installer and homeowner alike.



More Energy

- Power optimisers increase rooftop energy harvest
- PV power is stored directly in the battery
- DC coupled battery solution allows high system efficiency, as there are no additional conversions from AC to DC and back to AC



Simple Design and Installation

- A single inverter for PV, storage and backup power
- Outdoor installation allows flexibility in battery location
- No special wires are required > utilises the same PV cables



Full Visibility and Easy Maintenance

- Monitor the battery status, PV production, and self-consumption data
- Smarter energy consumption to reduce electricity bills
- Monitor battery energy levels and remaining hours of backup power
- Remote diagnostics
- Remote firmware upgrades to both inverter and battery



Enhanced Safety



- PV array and battery voltage reduced to a safe voltage automatically upon AC shut down when not in backup mode
- Complies with VDE 2100-712 and IEC 60947

PV System with DC-Coupled Storage

solar**edge**

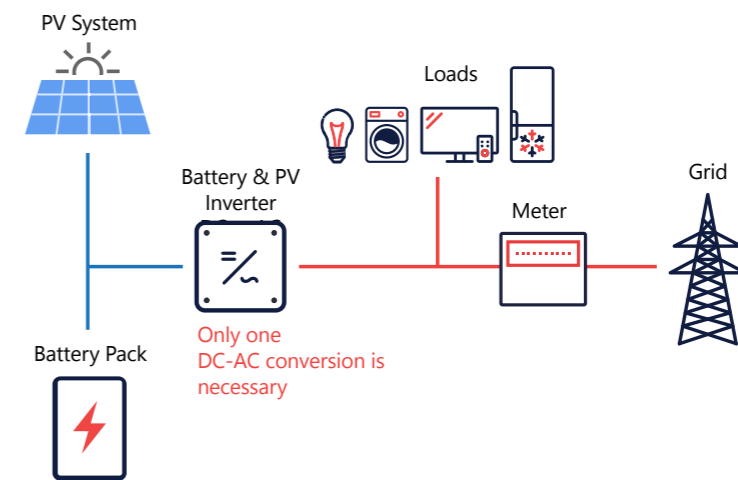

Vs.

PV System with AC-Coupled Storage

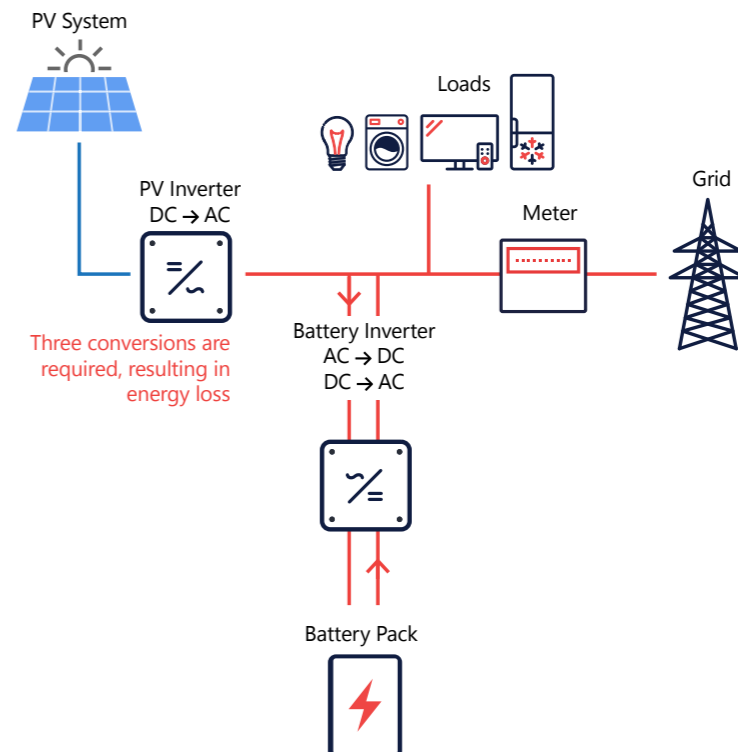

Basic StorEdge DC-Coupled Applications

Optimising Self-Consumption

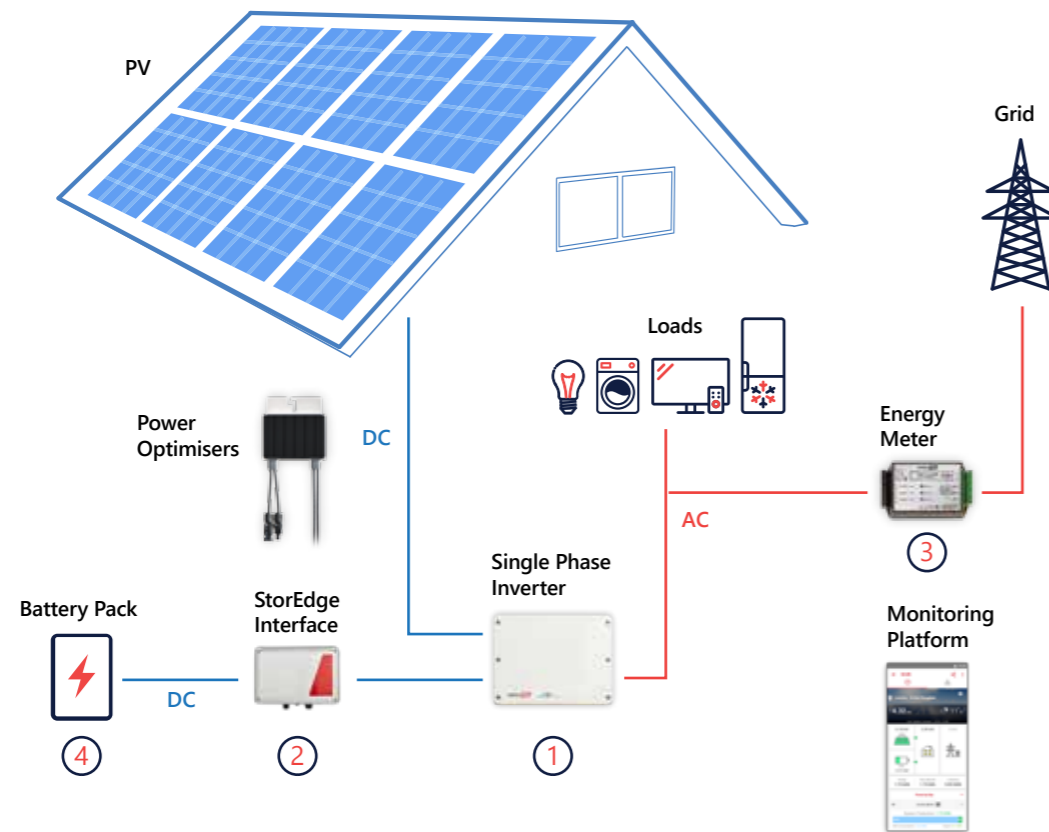

1. Single Phase Inverter

The inverter manages battery and system energy, in addition to its functionality as a PV inverter

2. StorEdge Interface

Connects the battery to a SolarEdge inverter
Connects to the inverter in parallel to the PV strings

3. Energy Meter with Modbus Connection and Current Transformers

For measuring electricity import and export
The energy meter is required for self-consumption management

4. Battery Pack

Compatible with DC coupled, high-voltage and high-efficiency batteries from LG Chem

Compatible with LG Chem

Optimising Self-Consumption + Backup Power

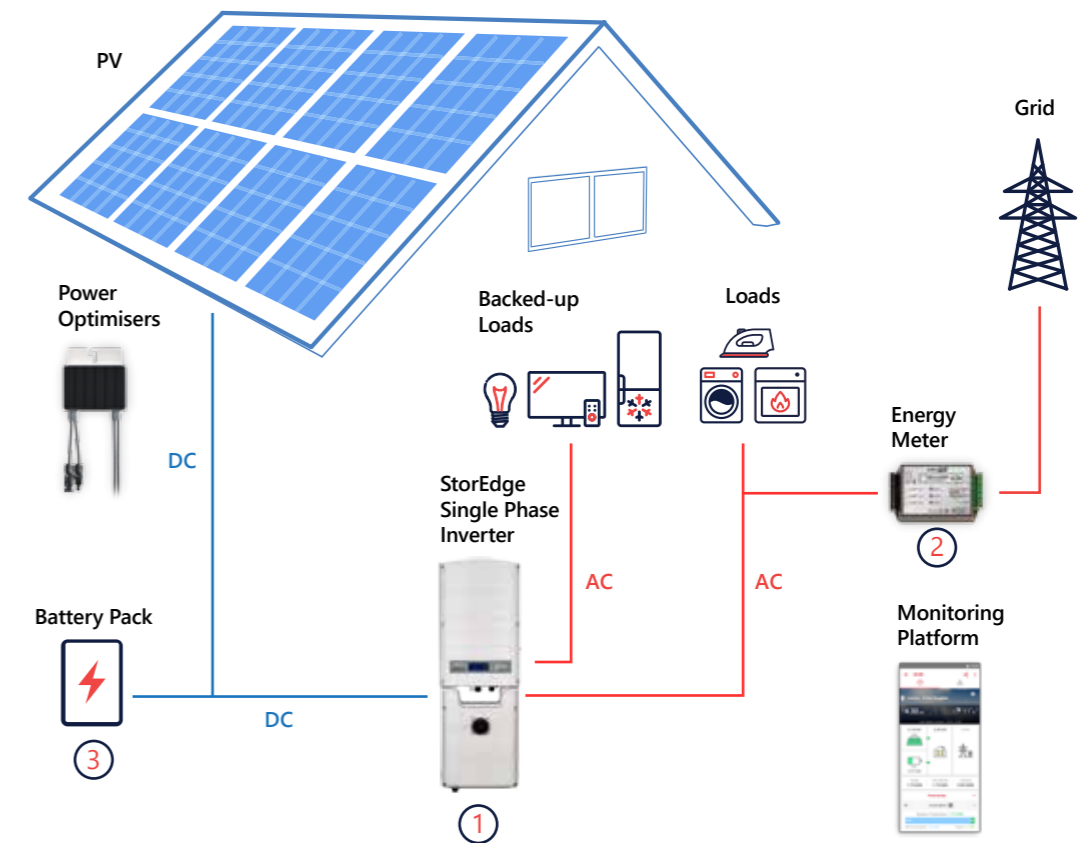

1. StorEdge Single Phase Inverter

The inverter manages battery, system energy and backup power, in addition to its functionality as a PV inverter

2. Energy Meter with Modbus Connection and Current Transformers

For measuring electricity import and export
The energy meter is not required for a backuponly solution

3. Battery Pack

Compatible with DC coupled, high-voltage and high-efficiency batteries from LG Chem

Compatible with LG Chem

Advanced StorEdge Configurations

More PV Power

A second single phase inverter is added for the purposes of handling the additional PV power needed.

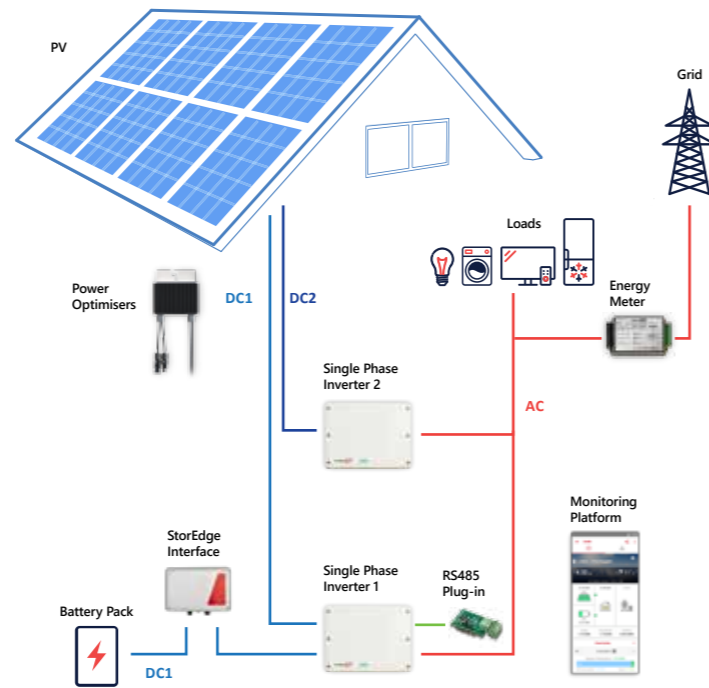

Connection to a non-SolarEdge inverter

To upgrade existing single or three phase non-SolarEdge PV installations, the StorEdge system, including an additional single phase inverter, connects to the non-SolarEdge inverter's AC output (AC-coupled). The SolarEdge inverter charges the battery using the PV power produced by the non-SolarEdge inverter.

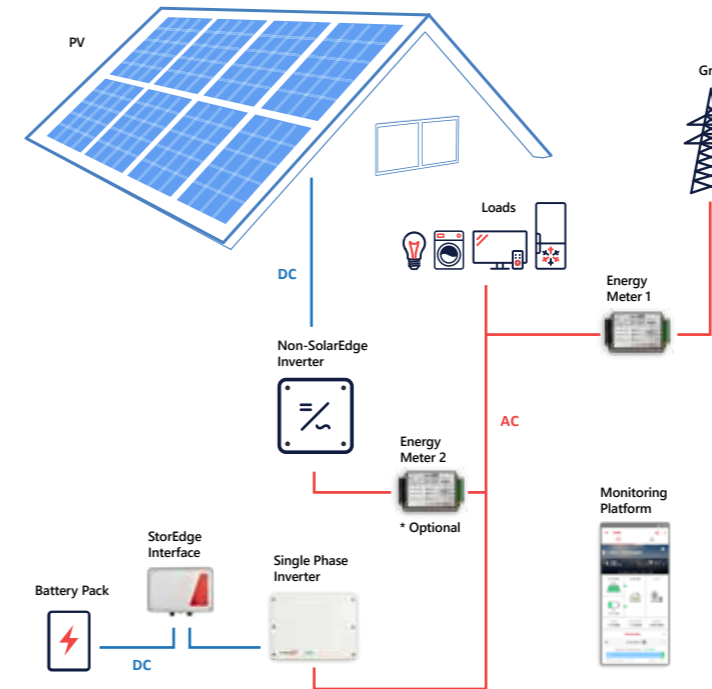

* Optional - needed for full system monitoring: consumption, self-consumption and inverter production

Connection to a SolarEdge Three Phase Inverter

For installations using a SolarEdge three phase inverter, the StorEdge system, including an additional single phase SolarEdge inverter, connects to the three phase inverter's AC output (AC-coupled)

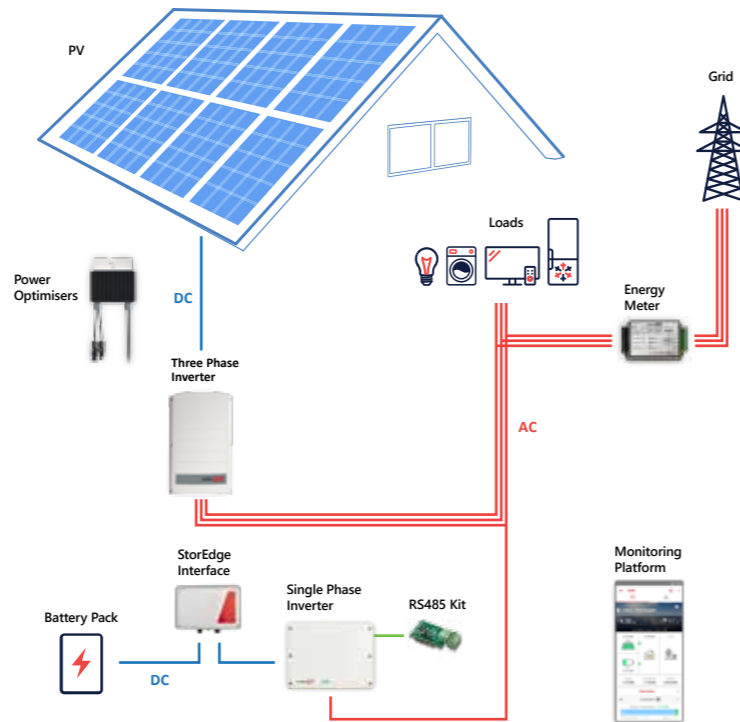

Backup Power without PV

A StorEdge system may be installed for sites without a PV system requiring backup power. The battery is charged from the AC grid only.

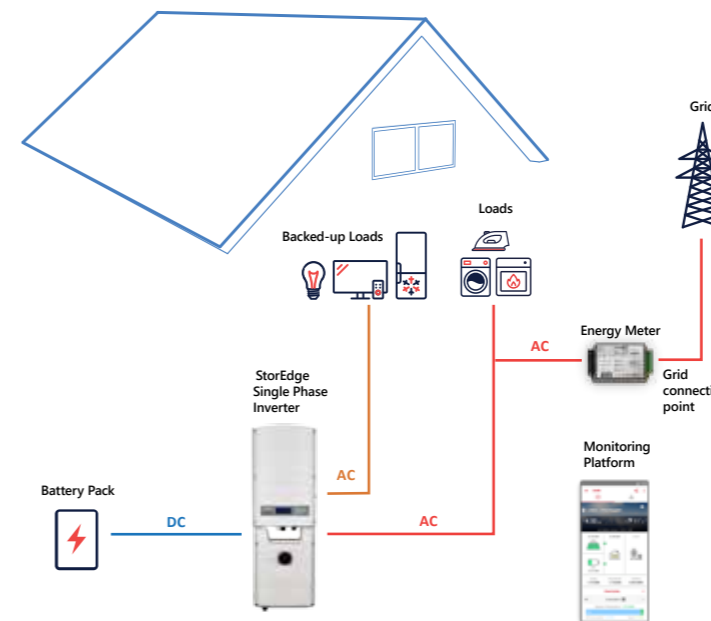

StorEdge Case Study: Increasing Self-Consumption

By simply adding StorEdge to its existing SolarEdge PV system, this typical household was able to more than double its self-consumption levels.

Before – monitoring self-consumption:

5kW System on April 8, 2015 (before battery installation)

Total produced energy	Total purchased energy	Total consumed energy	Self-consumption level
21.37 kWh	13.57 kWh	20.61 kWh	7.04kWh 33%

After – increasing self-consumption:

5kW System on April 15, 2015 (after battery installation)

Total produced energy	Total purchased energy	Total consumed energy	Calculated self-consumption level
25.41 kWh	3.17 kWh	21.53 kWh	18.36kWh 72%

During the day, PV powers the house, less energy is purchased

When there is no PV, all consumed energy is purchased from the grid

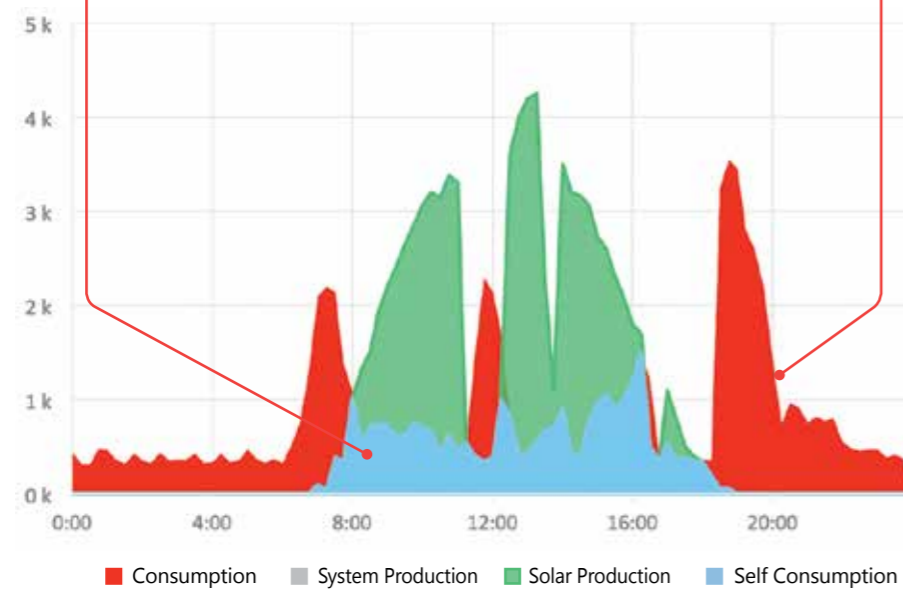

During the day, PV powers the house and charges the battery

When there is no PV, the battery is discharged; less energy is purchased

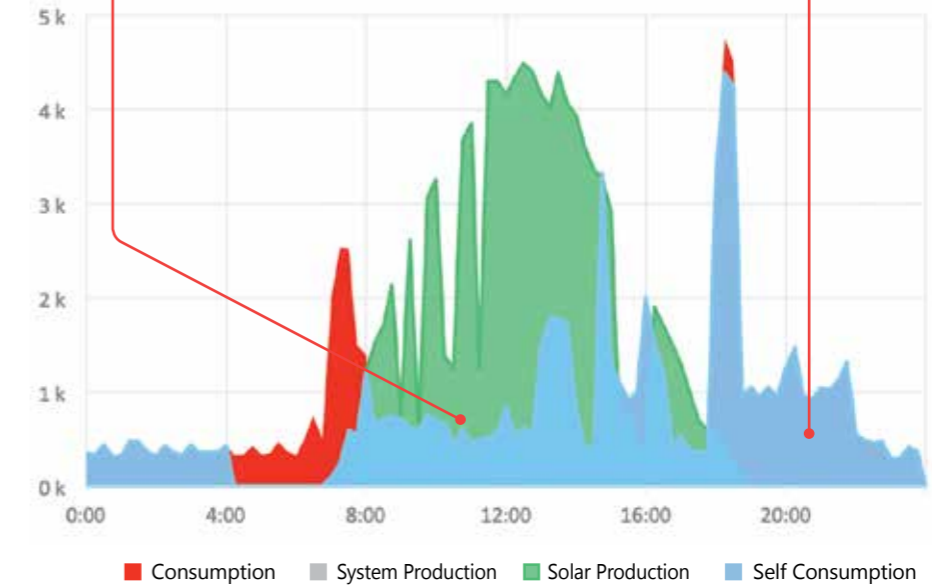

*Based on a SolarEdge 5kW residential PV system

After installing StorEdge, PV self-consumption jumped from 33% to 72%

Smart Energy Products

Designed to automatically use the PV system's excess power to increase solar energy usage, SolarEdge's smart energy products help the homeowner achieve lower electricity bills, increased energy independence, and greater convenience. The smart energy suite combines solar energy, storage management smart energy under the control of a single SolarEdge inverter.



Smart Energy Applications



Smart Energy Hot Water

Wireless controller automatically diverting excess PV energy to the hot water boiler, providing hot water and highly cost-effective energy storage



Smart Energy Switch & Smart Energy Socket

Wireless switch for controlling electrical loads, such as pool pumps, fans, lighting and other home appliances



Smart Energy Relay

Wireless relay for controlling high loads using an external control interface, such as smart grid-ready supported heat pumps

Control in the Palm of Your Hand

Use SolarEdge smart switches to control household appliances remotely and on-the-go, anytime, anywhere, via the SolarEdge monitoring mobile app.

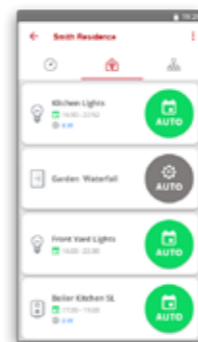

Smart energy monitoring dashboard

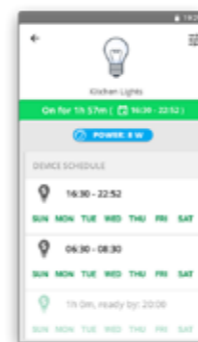

Set water heater schedule

The Benefits of Using Smart Energy Products

It's Automated

A smart, self-learning system featuring efficient use of excess solar energy to power appliances

It's Modular

Homeowners have the flexibility to choose from several solutions and install a system best fitting their present and future energy needs, for maximised self-consumption

It's User Friendly

Simple and intuitive user interface to monitor system performance and remotely control devices

The Added Value of the Smart Energy Hot Water

A typical UK home with a 4kW PV system, before and after installation of the smart energy hot water device*

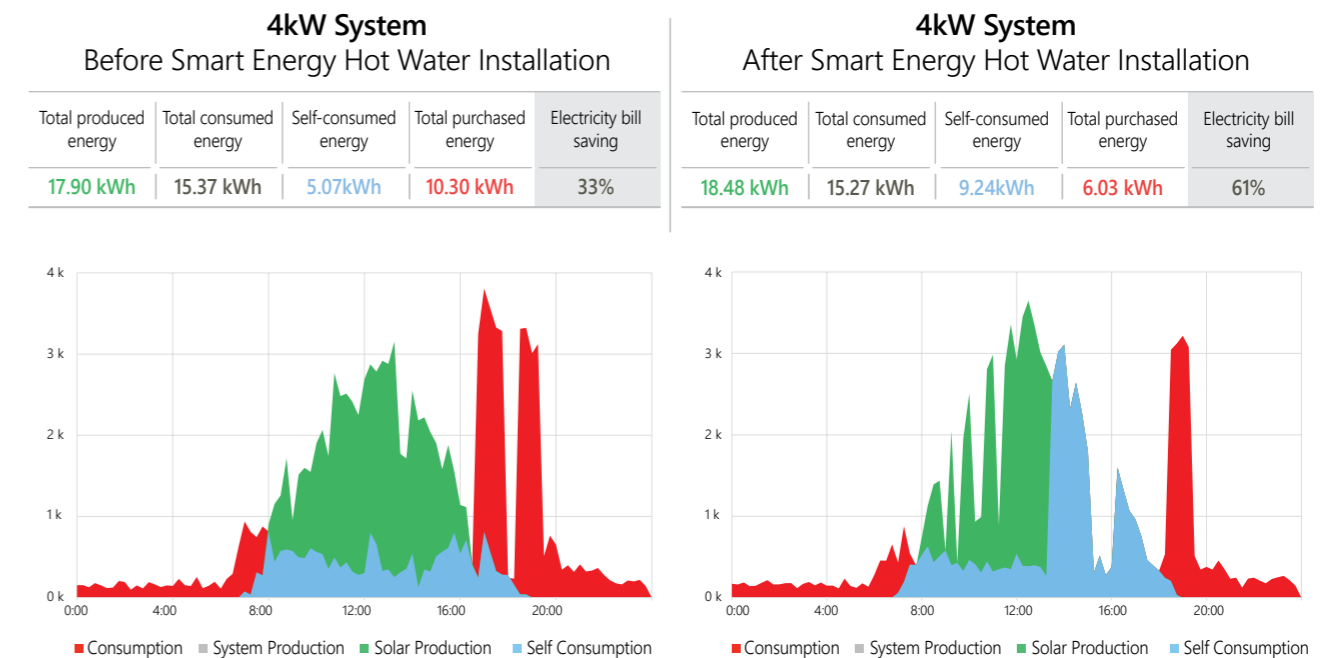

* Reduces electricity (or gas) consumption for water heating

Export Limitation Solution

Reduce Electricity Bills, Increase Your Self-Consumption

Grid electricity prices are constantly on the rise. This situation motivates the installation of large PV systems that allow owners to minimise consumption from the grid during the day. However, in some countries local regulations limit the amount of PV power that can be exported to the grid or allow no export whatsoever, while allowing the use of PV power for self-consumption. Therefore, without an energy management system, PV systems cannot be installed (if no export is permitted) or are limited in size.

SolarEdge offers an export limitation option, integrated in the SolarEdge inverter firmware, which dynamically adjusts PV power production. This allows you to use more energy for self-consumption when the loads are high, while maintaining the export limit also when the loads are low.

SolarEdge Export Limitation

- Export limitation is integrated into the inverter firmware - install only an energy meter
- Fast Response Time - ensuring that even with rapid changes in load consumption and PV production the export power does not exceed the limit
- Failsafe Operation - the operation is designed to guarantee that the exported power will never exceed the preconfigured limit under any fault

SolarEdge Inverter as Energy Manager

- Export limit is configured via the inverter user interface
- In a multi-inverter system, one inverter will serve as the energy manager
- Installed SolarEdge inverters can be firmware upgraded with the export limitation option

Meter Support

- The inverter can read a meter installed either at the grid connection point or at the load consumption point
- Two types of meters may be used:
 - An RS485 meter, available from SolarEdge; the meter connects to the RS485 terminal block of the SolarEdge inverter
 - A meter with an S0 interface and an S0 meter adapter cable available from SolarEdge
- The inverter maintains the output power limit with accuracy equal to that of the meter



Export Limitation Operation Example

The following example illustrates the behavior of a 6kW PV system, with an export power limit of 0W - no export to the grid.

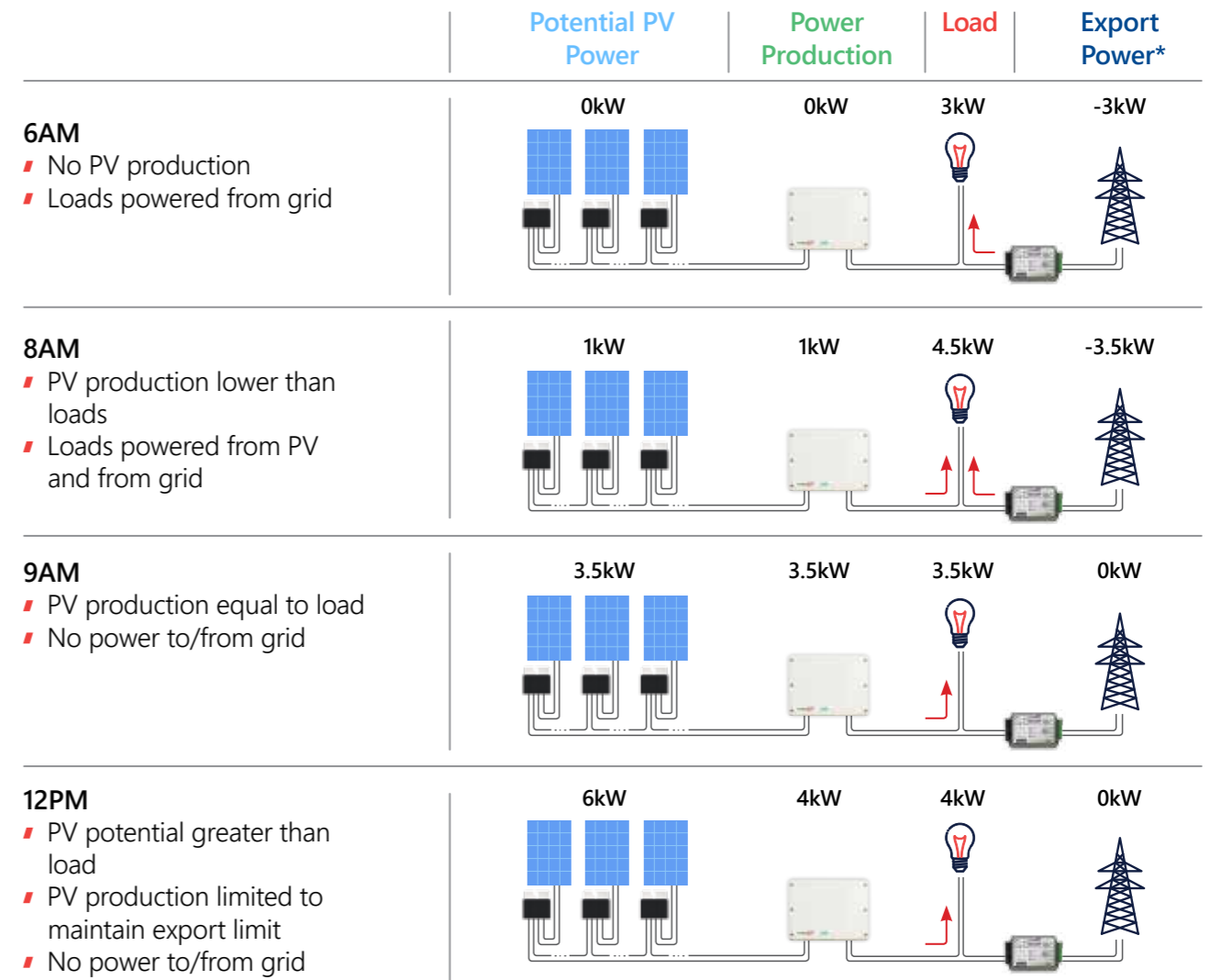

* Minus sign indicates power is purchased from the grid

The overall behaviour of the example system throughout the day can be seen in the following chart:

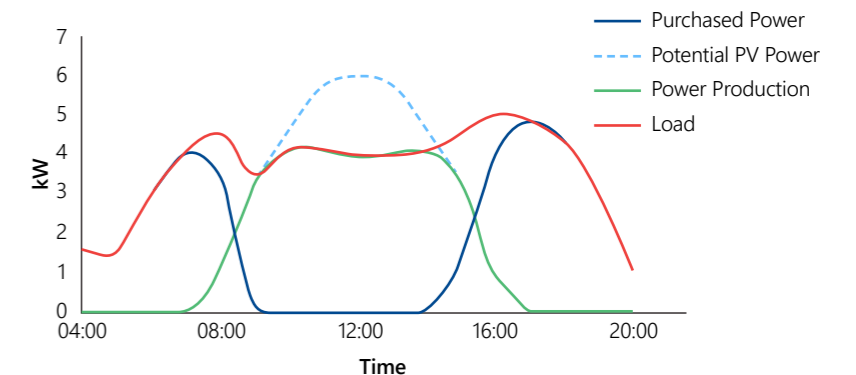

Faster, Easier PV System Design

The Designer is a free web-based tool that helps you lower your PV design costs and close more deals by making more compelling customer proposals. Use the online tool to plan, build and validate your SolarEdge systems from inception to installation.

Access the Designer platform via the Login menu on the SolarEdge homepage.

Save Time and Money

- Design PV systems using the latest satellite imagery — no reason to perform an onsite survey prior to first customer meeting
- Free for use — no need for expensive design tools to perform basic tasks
- Maximise roof utilisation and enjoy SolarEdge design flexibility advantages with instant validation
- Eliminate costly installation mistakes by creating visual wiring diagrams of your PV system



Close More Deals

- Impress your customers with a visually attractive 3D simulation of their roof
- Make quick, on-the-fly design modifications based on homeowner feedback
- Offer more compelling customer proposals with Designer's comprehensive reports and accurate energy simulations



Enjoy a Modern, Intuitive Platform

- Clean, interactive, graphical interface
- Web-based access from any Mac or PC
- Multi-user access to your Designer account for easy project collaboration automatic upgrades — no need to install new versions or download datasets



Working with SolarEdge

SolarEdge offers its PV installers valuable services to help make your experience positive and efficient.

Support

Comprehensive pre and post-sale technical services include technical documentation, personal project-based technical consulting, and more. Do not hesitate to contact the SolarEdge support team with for technical or service support. Simply open a case via the Support tab of your SolarEdge monitoring dashboard or the SolarEdge website **Support** page.

Training

Expand your knowledge of SolarEdge products and solutions. The SolarEdge website **Training** page links directly to webinars and E-learning courses. There you'll also find registration links to SolarEdge training seminars taking place in a location near you.

Alliance Program

Welcome to the Alliance program where you can accumulate 15 points for every kW of SolarEdge systems that you register on the monitoring platform. Redeem your points for promotional materials or gifts, perfect for company employees or family members.

Redeem points by accessing your **Alliance account** via the SolarEdge website.

Marketing Tools

Access marketing collateral to help you sell SolarEdge solutions: visit the SolarEdge website **Downloads Center** to access product catalogs, brochures, case studies, datasheets and more.

Contact your local SolarEdge sales or marketing person for more information about marketing and support services.



SolarEdge at home



Solar energy makes you strong



Teamwork to take this roof solar

Residential Product Offering

CLICK ONE OF THE RED ICONS TO LEARN MORE ABOUT EACH PRODUCT
To view online, scan the QR code or copy the link: solaredge.com/offering-SA



Complete Residential PV Solution



Movie | Installer catalog | Homeowner brochure

Single Phase Inverters with HD-Wave Technology

2.2kW-6kW



Movie | Datasheet

Three Phase Inverters

3kW-10kW



Datasheet

Power Optimisers

Panel-level optimisation
P300-P505



Datasheet

Monitoring Platform

Free, real-time system visibility at the panel level



Movie

EV Charging Single Phase Inverters



Expand homeowner's PV usage with the world's first EV charging inverter



Brochure

StorEdge™ for On-Grid Applications



Stores unused PV power on a battery for maximised self-consumption



Movie | Brochure | Datasheet

StorEdge™ with Backup Power

Maximises self-consumption and provides backup power when grid is down



Movie | Brochure | Datasheet

Smart Energy

Utilises excess PV for increased self-consumption and lower electricity bills



Movie | Smart energy hot water datasheet | Smart energy devices datasheet

Single Phase Inverters with Compact Technology

For small rooftop systems of 4-8 panels



Brochure | Datasheet

Wireless Communication

Multiple options for wireless connection of inverters to the internet e.g. for monitoring



Cellular plug-in datasheet | ZigBee plug-in datasheet | Wi-Fi plug-in datasheet

Energy Meter and Current Transformers





Supports high accuracy production/consumption monitoring, and export limitation





Datasheet

SolarEdge Ordering Information

Contact your local SolarEdge distributor for more details

Part Number	Product Description	
Single Phase Inverters with HD-Wave Technology; with SetApp Inverter configuration; 7-year warranty included		
SE2200H-ZA000BNN4	1ph Inverter with HD-Wave Technology, 2.2kW, (-40°C)	
SE3000H-ZA000BNN4	1ph Inverter with HD-Wave Technology, 3.0kW, (-40°C)	
SE3500H-ZA000BNN4	1ph Inverter with HD-Wave Technology, 3.5kW, (-40°C)	
SE4000H-ZA000BNN4	1ph Inverter with HD-Wave Technology, 4.0kW, (-40°C)	
SE5000H-ZA000BNN4	1ph Inverter with HD-Wave Technology, 5.0kW, (-40°C)	
SE6000H-ZA000BNN4	1ph Inverter with HD-Wave Technology, 6.0kW, (-40°C)	
Three Phase Inverters; with SetApp Inverter configuration; 7-year warranty included		
SE4K-ZA0TEBNN4	3ph Inverter, 4.0kW, (-40°C)	
SE5K-ZA0TEBNN4	3ph Inverter, 5.0kW, (-40°C)	
SE7K-ZA0TEBNN4	3ph Inverter, 7.0kW, (-40°C)	
SE8K-ZA0TEBNN4	3ph Inverter, 8.0kW, (-40°C)	
SE9K-ZA0TEBNN4	3ph Inverter, 9.0kW, (-40°C)	
SE10K-ZA0TEBNN4	3ph Inverter, 10.0kW, (-40°C)	
SE12.5K-ZA000BNN4	3ph Inverter, 12.5kW, (-40°C)	
StorEdge; 7-year warranty included for the inverters and 10-year warranty included for the interface		
SESTI-S2	StorEdge Interface (for self-consumption only), with LG Chem RESU 10H Battery	
SESTI-S4	StorEdge Interface for 1ph Inverters with HD-Wave Technology (for self-consumption only), with LG Chem RESU 7H & 10H Batteries	
SE5000-ZAS20NNB2 *	StorEdge 1ph Inverter (with Backup), 5kW	
SE6000-ZAS20NNB2 *	StorEdge 1ph Inverter (with Backup), 6kW	
SE3680H-ZASACNNN2	StorEdge AC Coupled 1ph Inverter with HD-Wave Technology, 3.68kW	
SE5000H-ZASACNNN2	StorEdge AC Coupled 1ph Inverter with HD-Wave Technology, 5.0kW	
SE-1PH-STRG-K1	StorEdge Upgrade Kit for 1ph Inverter (not for 1ph Inverters with HD-Wave Technology)	
SE-3PH-STRG-K1	StorEdge Upgrade Kit for 3ph Inverter	

* StorEdge Inverters (with Backup) are available in certain countries. Check with your local SolarEdge sales person.

Part Number	Product Description	
Power Optimisers; 25-year warranty included		
P300-5RM4MRS	For 60 cells, with max Vin (@ min temp) 48V, output cable length 0.95m	
P370-5RM4MRM	For 72 cells, with max Vin (@ min temp) 60V, output cable length 0.95m	
P404-5RM4MRM	For 60/72 cells, with max Vin (@ min temp) 80V, output cable length 1.2m	
P405-5RM4MRM	For thin film panels, with max Vin (@ min temp) 125V, output cable length 1.2m, single input	
P405-5RMDMRM	For thin film panels, with max Vin (@ min temp) 125V, output cable length 1.2m, dual input	
P500-5RM4MRM	For 96 cells, with max Vin (@ min temp) 80V, output cable length 1.2m	
P505-5RM4MBM	For high current panels, with max lin 14A, with max Vin (@ min temp) 83V, output cable length 1.2m	
Frame-Mounted Power Optimisers; 25-year warranty included		
P300-5RM4MFS	For 60 cells, with max Vin (@ min temp) 48V, output cable length 0.95m	
P370-5RM4MFM	For 72 cells, with max Vin (@ min temp) 60V, output cable length 0.95m	
P404-5RM4MFM	For 60/72 cells, with max Vin (@ min temp) 80V, output cable length 1.2m	
P500-5RM4MFM	For 96 cells, with max Vin (@ min temp) 80V, output cable length 1.2m	

SolarEdge Ordering Information

Contact your local SolarEdge distributor for more details







Part Number	Product Description	
Communication Products; 5-year warranty included		
SE1000-WIFI01	Wi-Fi Plug-in	
SE-ANT-ZBWIFI-KIT	Antenna kit for Wi-Fi/ZigBee for Smart Energy (5 pcs)	
SE1000-ZBGW-K5	ZigBee Gateway and ZigBee Plug-in	
SE1000-ZBRPT05	ZigBee Repeater	
SE1000-ZB05-SLV	ZigBee Plug-in	
SE1000-RS485-IF	RS485 Plug-in	
SE-SIM-R12-EU-S1	SolarEdge 12-Year Prepaid Data Plan, for residential systems	
SE-SIM-R12-EU-S2	SolarEdge 12-Year Prepaid Data Plan, for StorEdge systems	
SE-1PH-GSM-K1	Communication Board and Cellular Plug-In Upgrade for Single Phase Inverters (not compatible with 1ph Inverters with HD-Wave Technology)	
SE-3PH-GSM-K2	Communication Board and Cellular Plug-In Upgrade for Three Phase Inverters	
SE1000-GSM02	Cellular Plug-in for Single Phase Inverters with HD-Wave Technology	
Metering Solutions		
SE-WND-3Y400-MB-K2	1ph/3ph 230/400V, Energy Meter with Modbus Connection, DIN-Rail, CLASS 05, V2	
SE-ACT-0750-50	50A Split-Core Current Transformer	
SE-CTML-0350-070	70A Small Split-Core Current Transformer	
SE-ACT-0750-100	100A Split-Core Current Transformer	
SE-ACT-0750-250	250A Split-Core Current Transformer	
SE-CTS-2000-1000	1000A Split-Core Current Transformer	
SE1000-S0IF01	S0 meter adapter cable	
Smart Energy; 5-year warranty included		
SEHAZB-HEAT-CONT-3	3kW Smart Energy Hot Water	
SEHAZB-SWITCH-MTR	Smart Energy Switch	
SEHAZB-DR-SWITCH-2	2 x Smart Energy Relay	
SEHAZB-SCKT-MTR-GB	Smart Energy Socket, Great Britain	
SEHAZB-SCKT-MTR-DE	Smart Energy Socket, Germany (EU)	
SE1000-ZB06-MOD *	Smart Energy ZigBee Plug-in	

Part Number	Product Description	
Inverter Warranty Extensions		
For single phase inverters with HD-Wave technology, purchased within 24 months of shipment date		
WE-HD1S-20	20 years, 1ph Inverter with HD-Wave Technology < 4 kW	
WE-HD1M-20	20 years, 1ph Inverter with HD-Wave Technology 4-6 kW	
Purchased within 24 months of shipment date, up to 20 years		
WE-1S-20	20 years, 1ph Inverter < 4 kW	
WE-1M-20	20 years, 1ph Inverter 4-6 kW	
WE-3M-20	20 years, 3ph Inverter <15 kW	
StorEdge Inverters, purchased within 24 months of shipment date, up to 25 years		
WE-S1S-20	20 years, StorEdge 1ph Inverter (with Backup)	
WE-S1S-25	25 years, StorEdge 1ph Inverter (with Backup)	
Monitoring & Installer Tools		
Free, real-time, panel-level monitoring of PV system performance via the SolarEdge monitoring platform. Accessible from your computer or mobile device.	For full details about the monitoring platform visit: http://www.solaredge.com/products/pv-monitoring#/	
Free, web-based PV design tool used to plan, build and validate your SolarEdge systems from inception to installation.	For full details about the Designer, visit: https://www.solaredge.com/products/installer-tools/designer#/	
Display Products		
SE6000H-RW-EMP	Demo 1ph Inverter with HD-Wave Technology	
SE8K-RW00E-EMP	Demo 3ph Inverter, 4-10kW	
SE17K-EMP	Demo 3ph Inverter, 12.5kW	
SESTI-S1-EMP	Demo StorEdge Interface	
SE5000-RWS-EMP	Demo StorEdge 1ph Inverter (with Backup)	

SolarEdge is a global leader in smart energy technology. By leveraging world-class engineering capabilities and with a relentless focus on innovation, SolarEdge creates smart energy solutions that power our lives and drive future progress.

SolarEdge developed an intelligent inverter solution that changed the way power is harvested and managed in photovoltaic (PV) systems. The SolarEdge DC optimised inverter maximises power generation while lowering the cost of energy produced by the PV system.

Continuing to advance smart energy, SolarEdge addresses a broad range of energy market segments through its PV, storage, EV charging, UPS, and grid services solutions.

 SolarEdge
 @SolarEdgePV
 @SolarEdgePV
 SolarEdgePV
 SolarEdge
 info@solaredge.com

solaredge.com

© SolarEdge Technologies, Ltd. All rights reserved. SOLAREEDGE, the SolarEdge logo, OPTIMIZED BY SOLAREEDGE are trademarks or registered trademarks of SolarEdge Technologies, Inc. All other trademarks mentioned herein are trademarks of their respective owners. Date: 06/2019/V01/ENG AFR. Subject to change without notice.

This document includes estimates of various parameters of the compared solar systems, including annual A/C energy production, performance ratio and shading loss based on PVsyst computer-simulated results for installations using our and competing systems. While we are not aware of any reason to believe these estimates and comparisons are materially inaccurate or misleading, they are inherently uncertain and the projected results are not guaranteed. Actual results will vary depending on a number of factors, including actual field conditions, quality of instalment and other variances from the assumptions underlying the estimates. Although care has been taken to ensure the accuracy, completeness and reliability of the estimates and comparisons presented, SolarEdge assumes no responsibility for these. MORE SPECIFICALLY, IN NO EVENT SHALL SOLAREEDGE BE LIABLE FOR ANY DIRECT, INDIRECT, SPECIAL OR INCIDENTAL LOSSES OR DAMAGES RESULTING FROM OR ARISING OUT OF USE OF OR RELIANCE ON THE ESTIMATES AND COMPARISONS PRESENTED.

 solar**edge**

