

Commercial Offering for Installers & EPCs



solaredge

Content

04	About SolarEdge
07	The Importance of Inverter Selection
08	Maximum Energy Yield in Commercial Installations
11	Design Flexibility
13	PV Asset Management with Panel-Level Monitoring
19	Superior Safety
21	Future Compatibility & Warranty
23	A Higher Lifetime Value
24	Commercial System Diagram
26	300kW Rooftop System Comparison
28	300kWp Electrical Diagram Comparison
30	1MWp Ground Mount System Comparison
32	1MWp Electrical Diagram Comparison
34	Commercial Product Offering
36	Commercial Offering Ordering Information
40	Comprehensive Service Suite

About SolarEdge

About us

In 2006, SolarEdge invented an intelligent inverter solution that has changed the way power is harvested and managed in PV systems. Today, we are a global leader in smart energy technology. By deploying world-class engineering capabilities and with a relentless focus on innovation, we create smart energy products and solutions that power our lives and drive future progress.

Vision

We believe that continuous improvement in the ways we produce and consume energy will lead to a better future for us all



Bankability

- SolarEdge has been audited and approved by major banks and financial institutions for projects and funds worldwide
- SolarEdge (SEDG) is traded on NASDAQ
- Our financial strength and stability, combined with our cutting-edge technology, has propelled us to become one of the largest inverter manufacturers in the world

Global reach

- Systems installed in over 130 countries across five continents
- Sales via leading integrators and distributors
- Follow the sun call centers
- Local teams of sales, service, marketing, and training experts
- Global manufacturing capabilities with tier 1 electronic manufacturing service companies



Received nearly 30 awards from prestigious organisations including Red Herring, Frost & Sullivan, Intersolar, the Stratus Award, and the Edison Awards™

Shipping since 2010

- Over 1.5 million inverters shipped worldwide
- SolarEdge's monitoring platform continuously tracks over a million installations across the globe

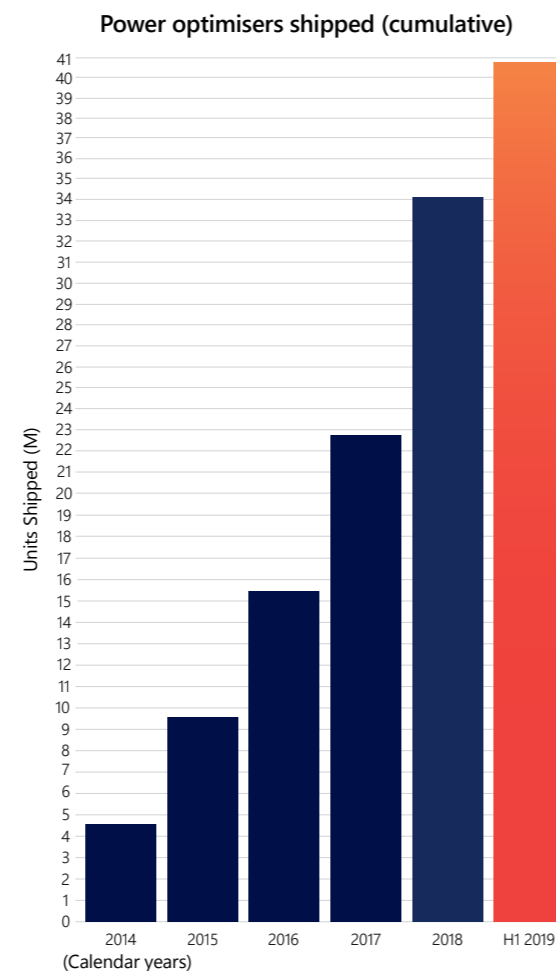

Corporate social responsibility

- As an industry leader in renewable energy technologies, SolarEdge strives to limit the harmful effects of traditional energy sources by promoting the spread of clean, sustainable energy around the world
- SolarEdge is in full compliance with international standards on quality and control, ethical conduct and environmental protection



Patents

SolarEdge has a vast portfolio of intellectual property, with hundreds of awarded patents and patent applications

Product reliability

- 25-year power optimizer warranty and 12-year inverter warranty, extendable to 20 years
- SolarEdge products and components undergo rigorous testing, and have been evaluated in accelerated life chambers
- Reliability strategy includes proprietary application specific ICs (ASIC)



The Importance of Inverter Selection

Commercial rooftop installation cost breakdown*

Inverters account for less than 10% of the system cost but,

- ▄ Manage 100% of system production
- ▄ Influence up to 20% of system cost
- ▄ Control O&M expenses through PV asset management solutions

Therefore, the inverter selection is critical for the long term financial performance of a PV system as it can maximise energy production and reduce lifetime costs.

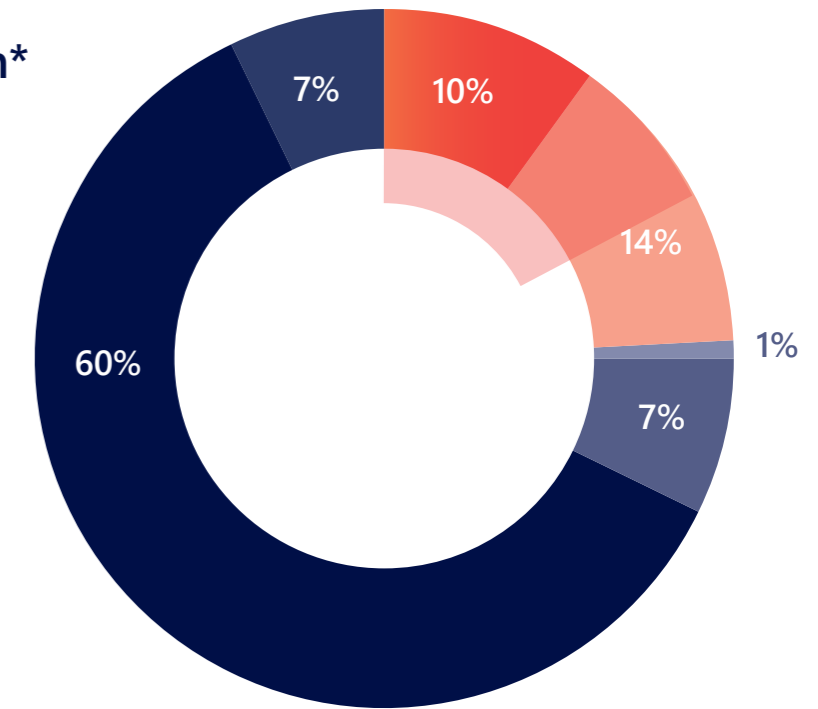

- ▄ Inverter
- ▄ EPC margin
- ▄ Electrical BOS
- ▄ PV panels
- ▄ Other
- ▄ Structural BOS

* Based on SolarEdge market analysis, assuming total cost of ~€1/Wp

Maximum Energy Yield in Commercial Installations

Unavoidable in commercial installations, panel-level mismatch occurs when panels in a string have different Maximum Power Points (MPPs). Arising from a variety of sources, the mismatch decreases the energy yield of the entire string.

Traditional string inverter

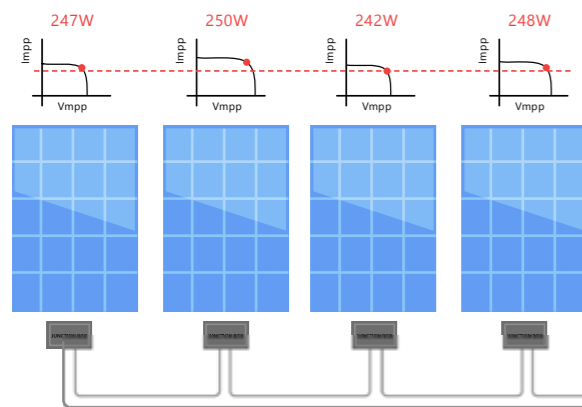

- MPPT per string - all panels operate at same current, regardless of their individual MPP
- Weak panels reduce the performance of all panels in the string or are bypassed
- Power losses due to panel mismatch

SolarEdge DC optimised inverter solution

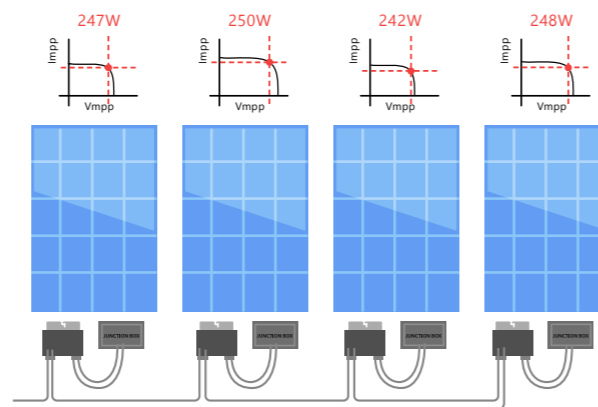

- Panel-level MPPT - current & voltage adjusted at the panel level
- Maximum power produced and tracked from each panel individually
- 2%-10% more energy from the PV system

The SolarEdge DC optimised inverter solution mitigates power losses caused by panel mismatch for maximum power generation from each panel. With SolarEdge, strong panels are not affected by the weaker ones.

Examples of power mismatch in commercial installations:

Manufacturing tolerance mismatch

The panel manufacturer-warranted output power range may vary greatly. A standard deviation of 3% is sufficient to result in ~2% energy loss.



Guaranteed power output from panel manufacturers
0~+3%

Soiling, shading & leaves

Panel soiling, from dirt, bird droppings or snow, contributes to mismatch between panels and strings.

While there may be no obstructions during site design, throughout a system's lifetime, a tree may grow or a structure may be erected that creates uneven shading.

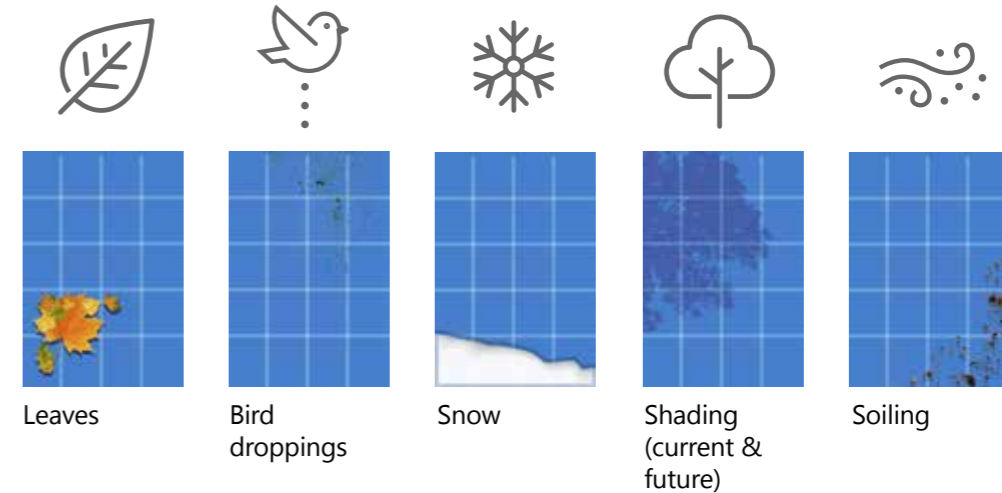

Uneven panel aging

Panel performance can degrade up to 20% over 20 years, however, each panel ages at a different rate, which causes aging mismatch.

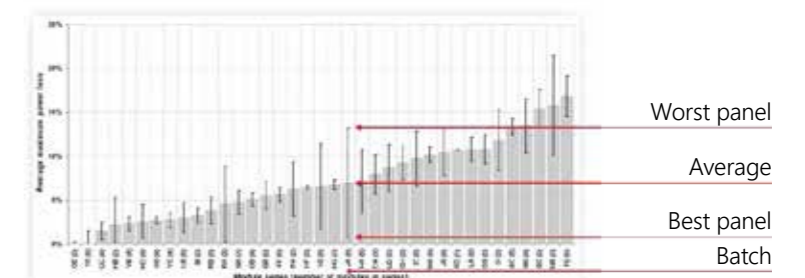

Source: A. Skoczek et. al., "The results of performance measurements of field-aged c-Si photovoltaic panels", Prog. Photovolt: Res. Appl. 2009; 17:227-240



Design Flexibility

More power

With panel-level power optimization and maximum design flexibility, more panels can be installed on the roof, enabling a shorter project payback period. SolarEdge power optimisers enable installation of:

- Panels in partially shaded areas
- Strings of uneven lengths
- Strings in multiple orientations and different roof facets



Standard inverter
149.5 kW DC

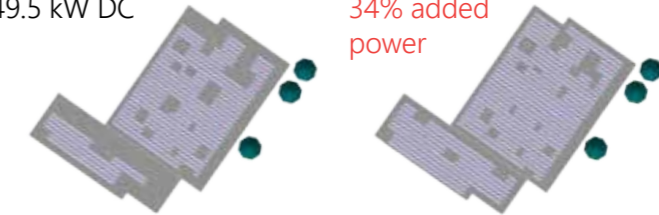

Reduced BoS cost

Up to 15kW per string allows for more panels per string. This leads to fewer strings per inverter and therefore less wiring, combiner boxes, and fuses.

■ SolarEdge DC optimised inverter

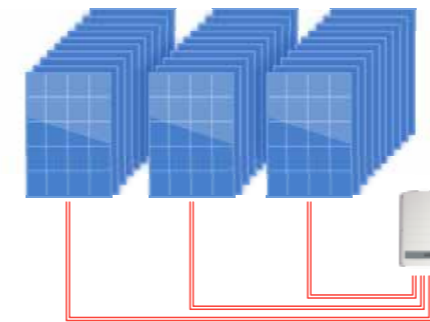

■ Traditional inverter

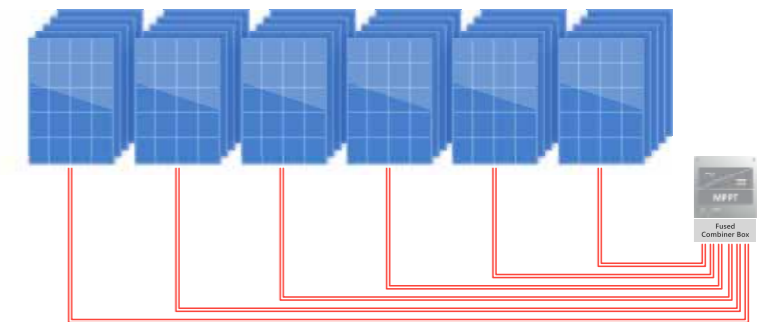



PV Asset Management with Panel-Level Monitoring



As equipment prices drop and system sizes trend upward, PV projects are increasingly seen as secure long-term investment opportunities. Like any financial asset, PV systems must be monitored and managed to realize their full potential.

Traditional inverters offer limited information, such as string-level or system-level monitoring that can indicate underperformance of the array, but little else. It then becomes costly and time consuming to send skilled technicians to perform on site troubleshooting.

The SolarEdge DC optimised inverter solution offers advanced PV monitoring and asset management. Power optimisers constantly track MPP and report high-resolution data on panel performance.

The SolarEdge monitoring platform transforms O&M from a manual, resource-intensive process to an automated, at-a-glance service, ensuring that every plant is performing to the best of its ability at all times.

145kW SolarEdge system, The Netherlands, installed by New Energy Systems

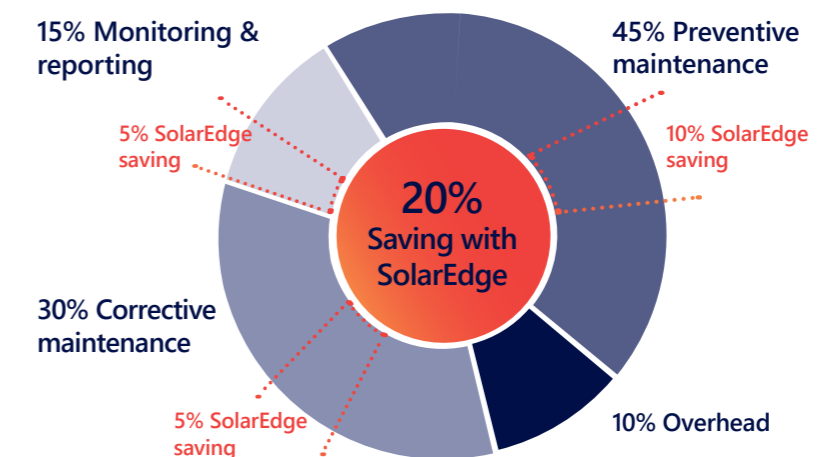

PV Asset Management with Panel-Level Monitoring (cont.)

SolarEdge's monitoring platform features:

1. Real-time remote monitoring at the panel, string, and system levels



The logical layout displays the electrical connectivity between panels, strings and inverter

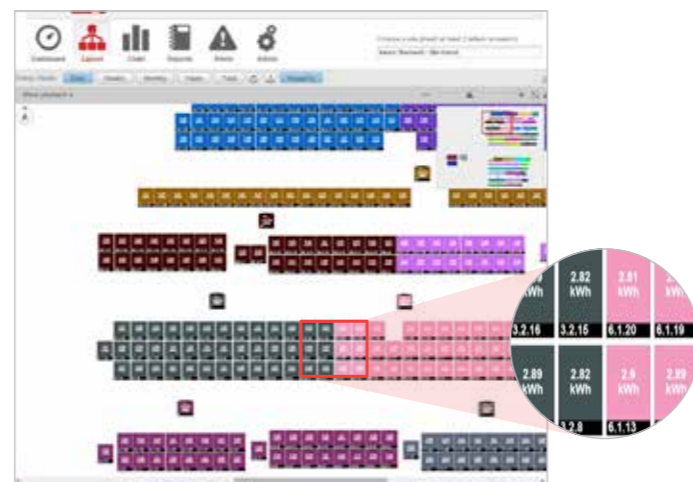

The hierarchy layout displays grouping of components per inverter

2. Comprehensive analytics tracking and reports of energy yield, system uptime, performance ratio, and financial performance

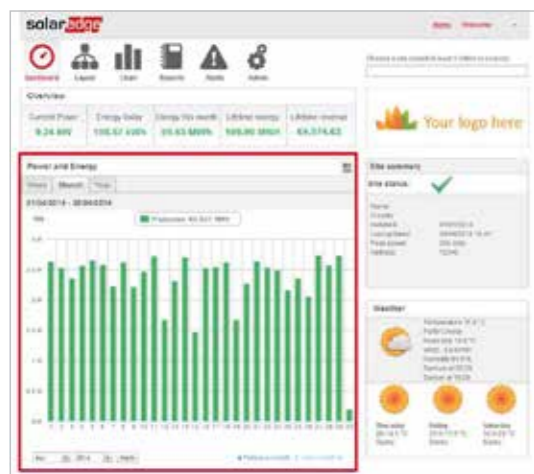

Dashboard - Energy production is displayed with weekly, monthly and yearly resolution

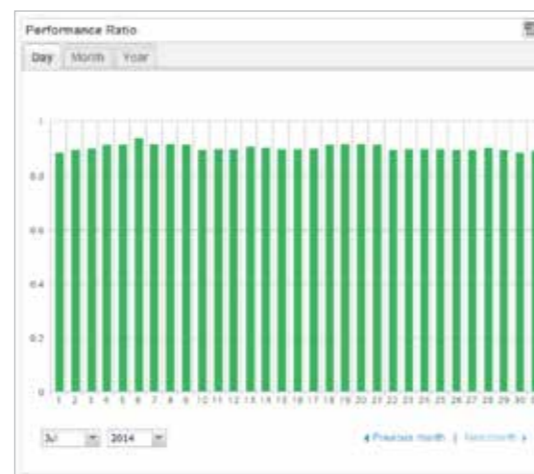

Performance Ratio - Analyze and track the system's performance ratio using satellite data or onsite sensors

3. Pinpointed and automatic alerts for immediate fault detection, accurate maintenance, and rapid response. The alerts show the specific fault location, fault description, and fault status. Energy thresholds alerts can be set to detect underperforming panels. Custom settings available for time of day and offset from sunrise and sunset.



Panel #	Manufacturer	Model	Serial Number	Last Measured	Current [A]	Optimiser Volt. [V]	Power [W]	Voltage [V]	Energy [kWh]
Panel 25.134	Trina Solar	TSM-235PC 05	00100290-04	04052014 8:	3.53	27.86	117.65	33.38	11,887.75
Panel 25.135	Trina Solar	TSM-235PC 05	00100290-09	04052014 8:	3.38	27.38	114.95	34	11,875
Panel 25.136	Trina Solar	TSM-235PC 05	00100483-0C	04052014 8:	3.49	18.13	77.3	22.13	7,558

4. The time-of-use feature allows system owners to define peak and off-peak rates in order to track expected PV revenue. This may be used as an indication of the systems ROI.

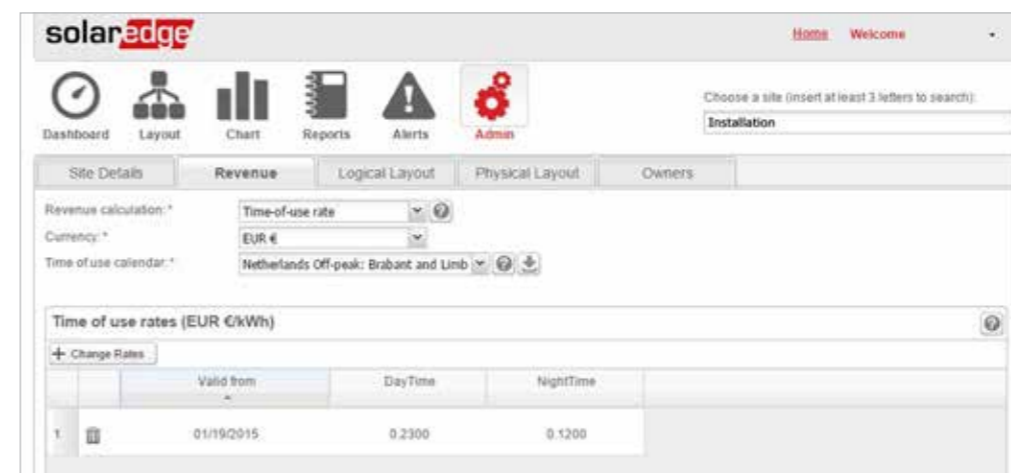

PV Asset Management with Panel-Level Monitoring (cont.)

- Accurate and remote troubleshooting for fast and efficient resolution with minimal and shortened onsite visits. Examples of identifying underperforming panels:

Soiling



Before cleaning



After cleaning

Potential induced degradation (PID)

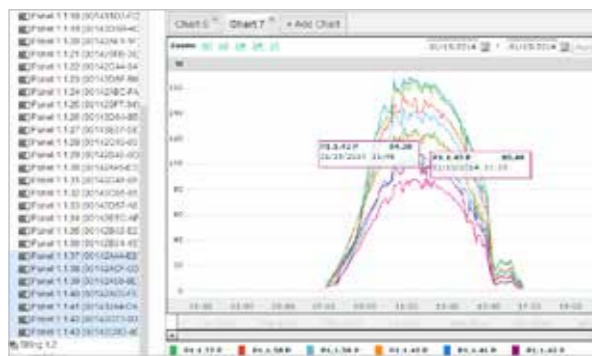

Looking at the panels within one string, it is possible to see the power degradation increasing towards the negative pole.

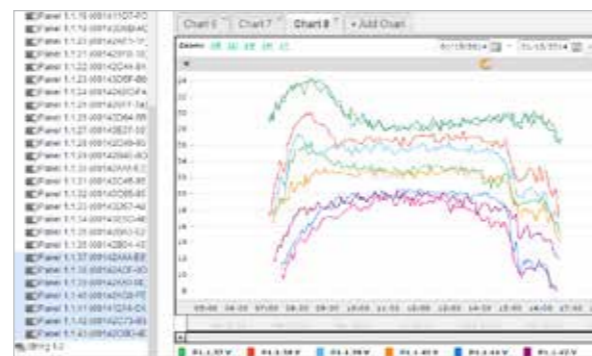

No need to send technicians to the roof – panel voltage is measured remotely

Bypass diode failure



It is easy to identify the bypass diode failure with the panel-level voltage graphs. The faulty panel outputs at only 2/3 of the voltage (5/6 in this case of power optimiser connected to two panels).

- The consumption monitoring feature shows data about electricity consumption, PV production, and self-consumption. This feature is integrated into all SolarEdge inverters and requires only a connection of a SolarEdge energy meter.





Superior Safety

With millions of photovoltaic (PV) systems installed worldwide, this technology is designed to be relatively safe and reliable. However, as traditional PV installations can reach voltages as high as 1,500VDC, precautions should be taken to ensure the safety of people and assets. With traditional inverters, shutting down the inverter or the grid connection will terminate current flow, but DC voltage in the string cables will stay high for as long as the sun is shining. In addition, electrical arcs, which can result in a fire, create a threat to people and assets in the vicinity of the PV system.

The SolarEdge system provides a superior safety solution for both electrocution and fire risks.

SafeDC™

SafeDC™ is a built-in panel-level safety feature which minimises electrocution risk.

To maintain string voltage below risk levels, power optimisers are designed to automatically switch into safety mode, in which the output voltage of each panel will be reduced to 1V in either of these cases:

- During installation, when string is disconnected from the inverter, or the inverter is turned off
- During maintenance or emergency, when the inverter or AC connection is shut down
- When the thermal sensors of the power optimisers detect a temperature above 85 °C

The SolarEdge SafeDC™ feature is certified in Europe as a DC disconnect according to IEC/EN 60947-1 and IEC/EN 60947-3 and to the safety standards VDE AR 2100-712 and OVE R-11-1.

Arc fault detection and interruption

SolarEdge inverters have a built-in protection designed to mitigate the effects of some arcing faults that may pose a risk of fire, in compliance with the UL1699B arc detection standard. Currently there is no comparable arc detection standard in the EU and therefore non-US SolarEdge inverters can detect and interrupt arcs as defined by the UL1699B standard. In addition to manual restart, a mechanism for auto-reconnect can be enabled during system commissioning.

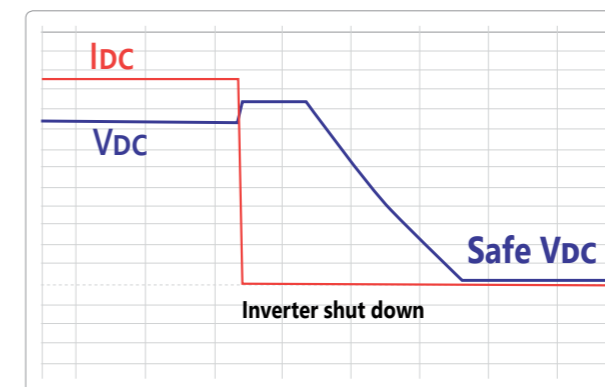

This graph represents an automatic string shutdown.

As demonstrated, the current is shut down immediately once AC power or inverter is turned off. The string voltage is reduced to safe voltage.



Future Compatibility & Warranty

As part of PV asset management planning, it is important to account for future costs that can impact the return on investment of a PV system. The SolarEdge DC optimized inverter solution effectively minimises these potential costs.

Forward compatibility eliminates expensive stock of spare panel inventory.

- Replacement: SolarEdge allows panels of different power classes and brands in the same string.
- Expansion: New power optimisers can be utilised in the same string with older models.

SolarEdge offers 25-year power optimiser warranty, 12-year inverter warranty, and free monitoring for 25 years. SolarEdge offers extended warranties at attractive prices.



Power optimisers
600W-850W



Three phase inverters
15kVA-100kVA



Monitoring platform

SolarEdge provides low-cost inverter replacement out of warranty

- ~40% less than traditional inverters

Products are certified for ammonia resistance - suitable for agricultural areas



756 kWp SolarEdge System, Farmington, IL
Installed by Clean Energy Design Group, Inc



A Higher Lifetime Value

The SolarEdge DC optimised inverter solution offers a better LCOE for a system's lifetime by maximizing yield and reducing costs.

The SolarEdge DC optimised inverter solution maximises power generation at the individual panel level, which leads to a higher lifetime revenue from PV systems. While the initial cost of the SolarEdge solution is generally slightly higher than the equivalent traditional inverter system, the total installation cost as well as the lifetime maintenance cost is lower. This makes the SolarEdge solution more economically attractive.

Lifetime PV system cost and revenue

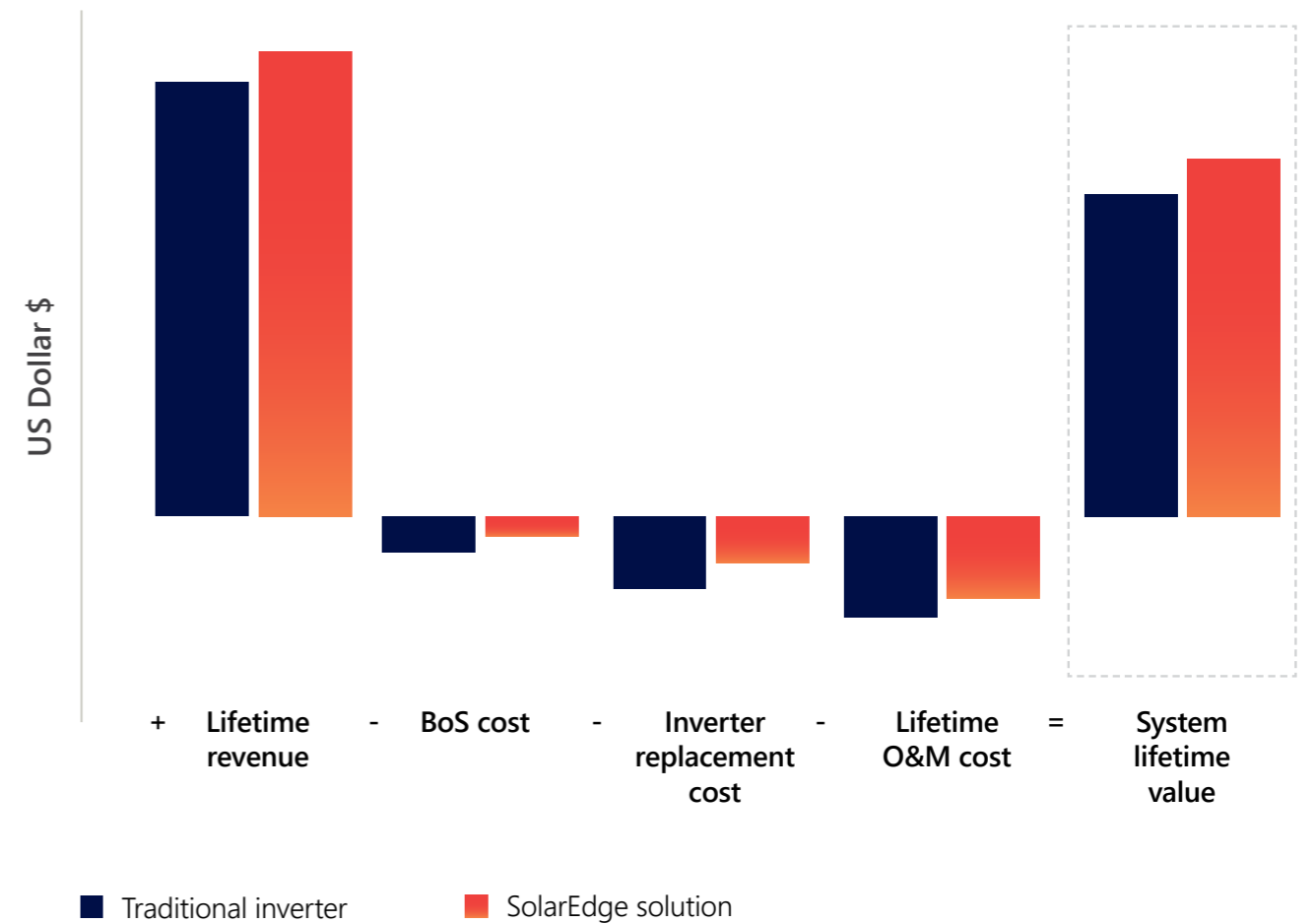

1.3MW SolarEdge system, Arizona, USA
 Developed by AES Distributed Energy, Inc. (formerly Main Street Power)
 Installed by Rosendin Electric

Commercial System Diagram

The SolarEdge solution consists of inverters, power optimisers, and a monitoring platform. The technology provides superior power harvesting and panel management by connecting power optimisers at the panel level. The ability to connect two panels to one optimiser, combined with DC to AC conversion and grid interaction being centralized at a simplified PV inverter maintains a competitive cost structure.

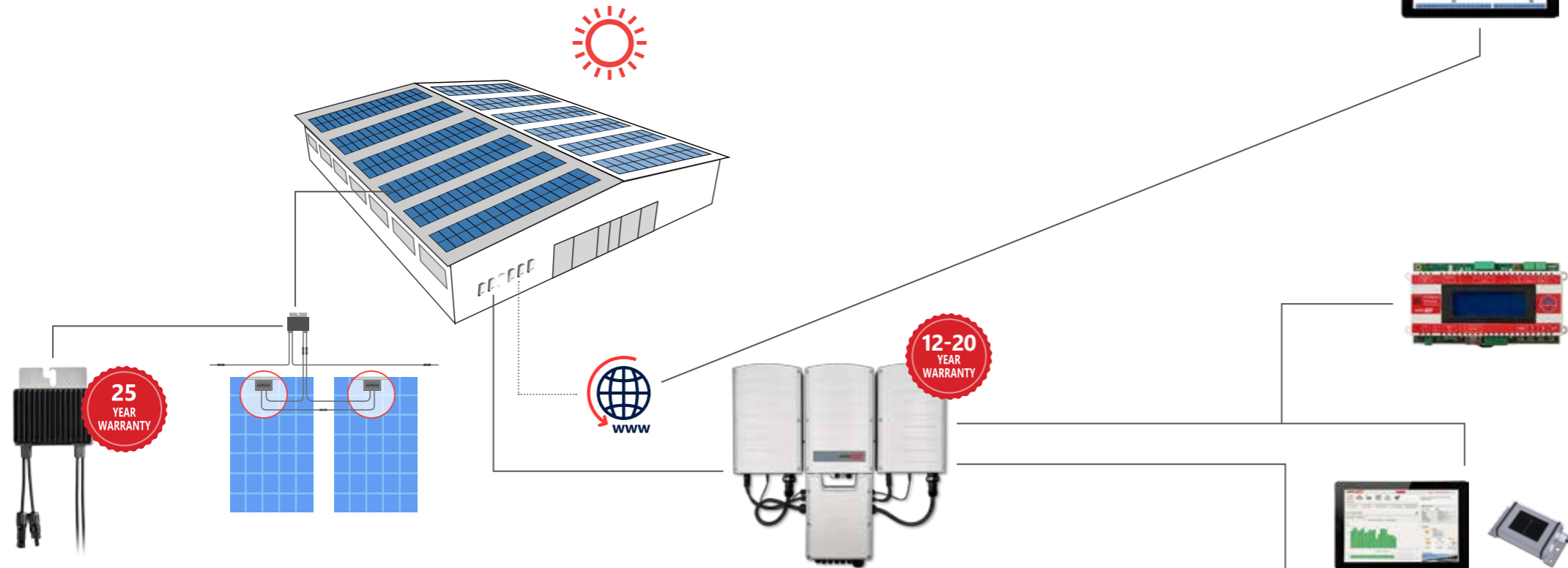

P600-P850 2-to-1 power optimiser configuration

- Panel-level MPPT - no mismatch power losses
- Strings of uneven lengths, panels on multiple azimuths & tilts
- Compatible with SolarEdge inverters SE15K & larger
- SafeDC™ - automatic panel-level safety shutdown

15kVA-100kVA inverter

- Specifically designed to work with power optimisers
- Superior efficiency
- Easy installation, including 2-person install for large capacity models
- Easy, step-by-step inverter activation and commissioning with the SetApp mobile application
- Built-in communication hardware, with optional cellular plug-in
- Optional integrated DC Safety Switch
- Embedded export limitation
- Built-in (optional) AC, DC, and RS485 surge protection (on selected models)

Monitoring platform

- Full visibility of system performance
- Remote troubleshooting
- Access via browser or any Android, iOS smart phone or tablet
- Communication with the power optimisers over existing DC power lines (PLC)

Firefighter gateway

- Can be added to the PV system to provide centralised safety management
- Gives real-time indication of the system's DC voltage

Performance monitoring

Calculate site performance ratio and measure environmental conditions, using environmental sensors or a satellite-based service.

Grid interaction

Supports power control, e.g. zero export limitation, local and remote active/reactive power control, inverter AC relay control for secondary grid protection; low voltage and frequency ride through.

300kW Rooftop System Comparison

Comparison of a 300kWp SolarEdge system to an identical system with a traditional string inverter

The system, in Amsterdam, The Netherlands, comprises 1,000 × 300Wp panels. One system was designed with 3 × SE82.8K SolarEdge inverters and 500 × P700 power optimisers in a 2:1 configuration. The second system was designed with 9 × 27.6kW traditional string inverters.

The SE82.8K model is a three phase inverter with synergy technology, combining large capacity with reduced installation time and cost. The inverter is based on three small and lightweight units; one primary unit easily connected to two secondary units. Up to 31 inverters can be configured directly from one master inverter for fast commissioning.

Energy comparison

PVsyst was used to simulate the yield of both systems in year 1 and year 20. The SolarEdge advantage is growing with time due to uneven panel aging which increases mismatch between panels.

	Traditional String Inverter	SolarEdge System	SolarEdge Advantage
PVsyst year 1 yield (MWh)	272.3	279.1	2.5%
PVsyst year 20 yield (MWh)	242.9	257.2	5.9%

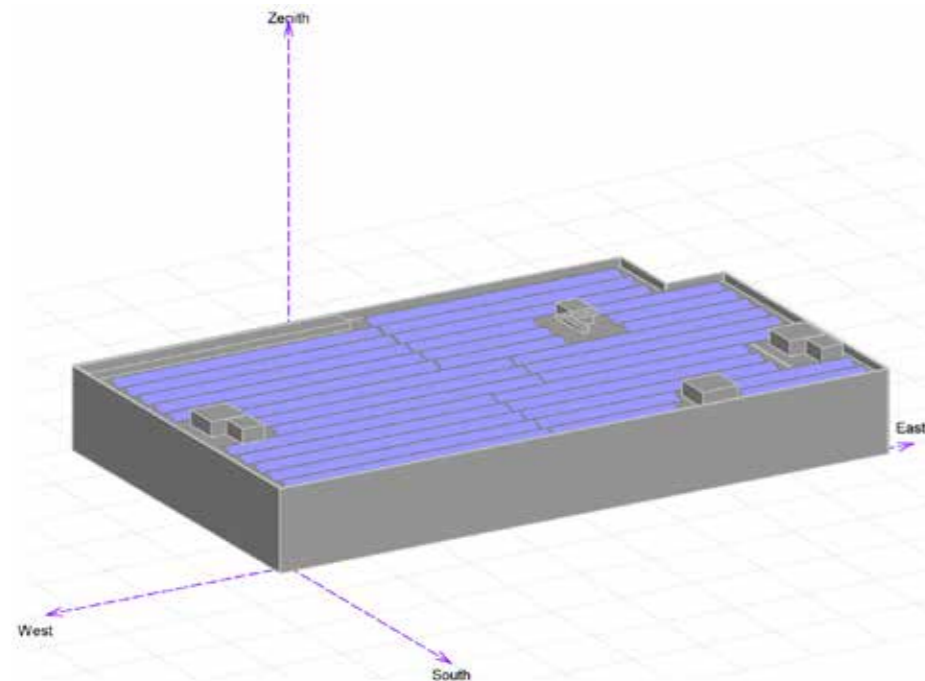

BoS comparison

	Traditional String Inverter	SolarEdge DC Optimised Inverter
DC power (kW)	300	300
AC power (kW)	248.4	248.4
Panels (300W, 72-cell)	1,000	1,000
Inverters	9	3
No. of strings	54	27
Panels per string	18/19	36/38
DC cable CU 1 × 6mm ² (m)	6,227	2,195
AC cable N2XY 4 × 16mm ²	54	-
AC cable N2XY 4 × 35mm ²	-	18
MC4 connectors (1 pair)	108	54
Datalogger	1	-
BoS cost	100%	33%
BoS cost saving*		1.19 c/w

* Estimated saving on BoS components based on typical market prices in €

Cabling comparison

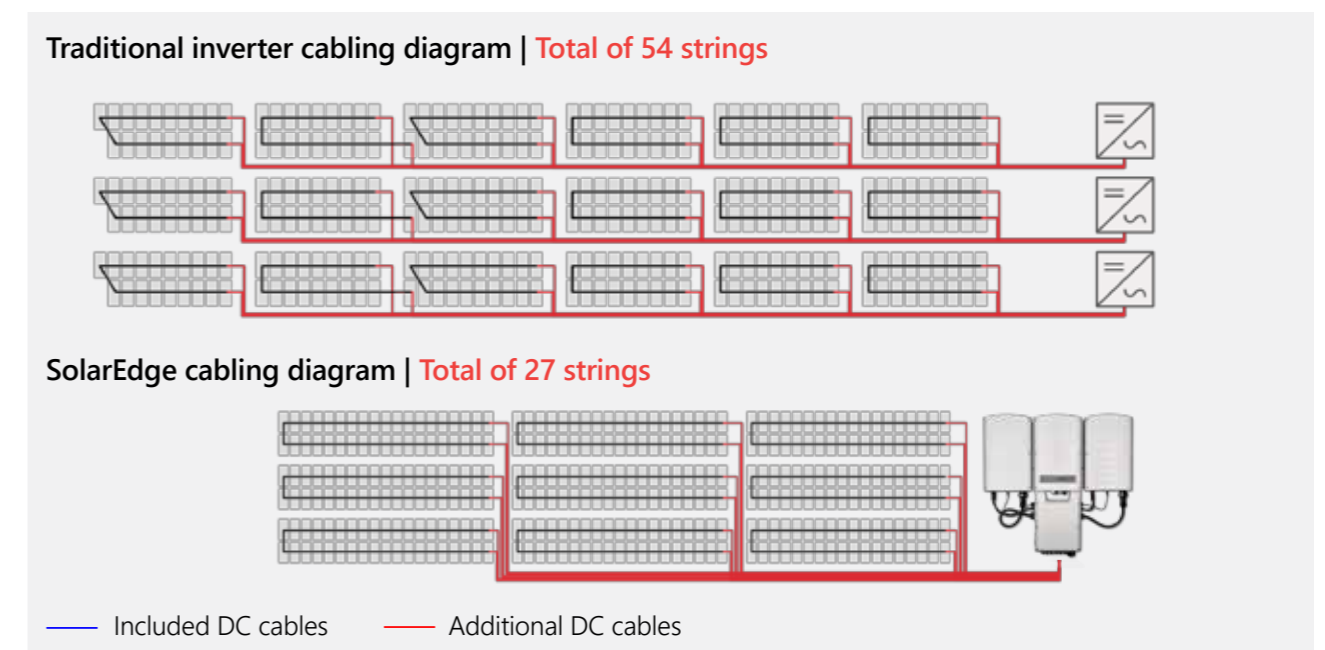

300kWp Rooftop System — Electrical Diagram Comparison

Traditional string inverter system

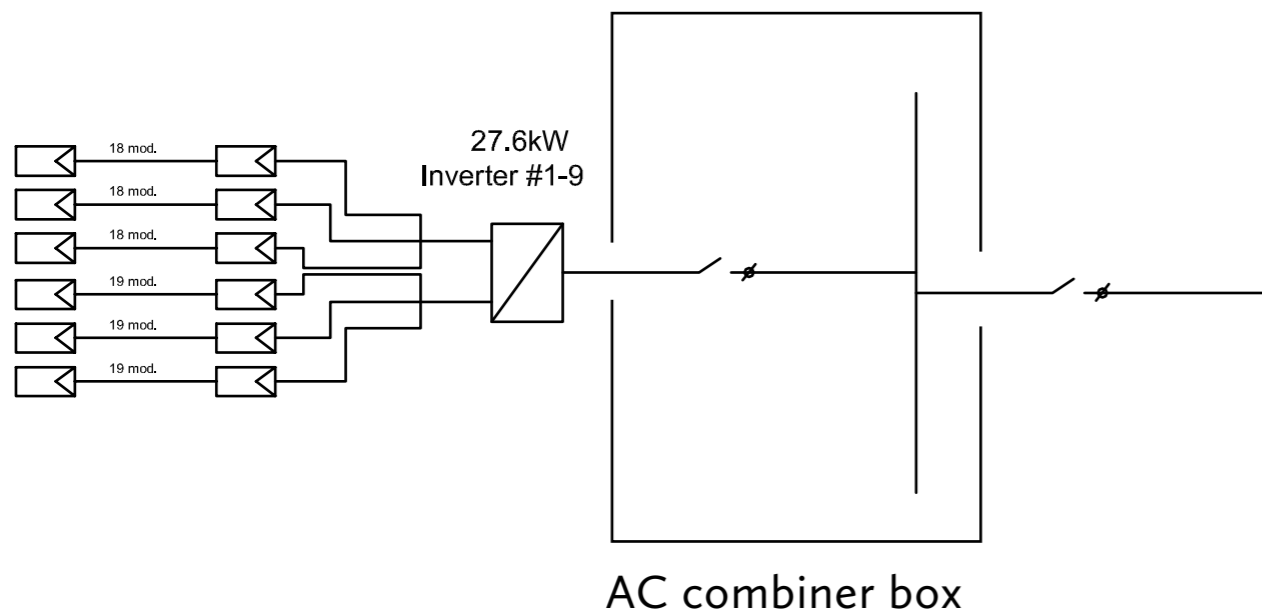

SolarEdge DC optimised inverter solution

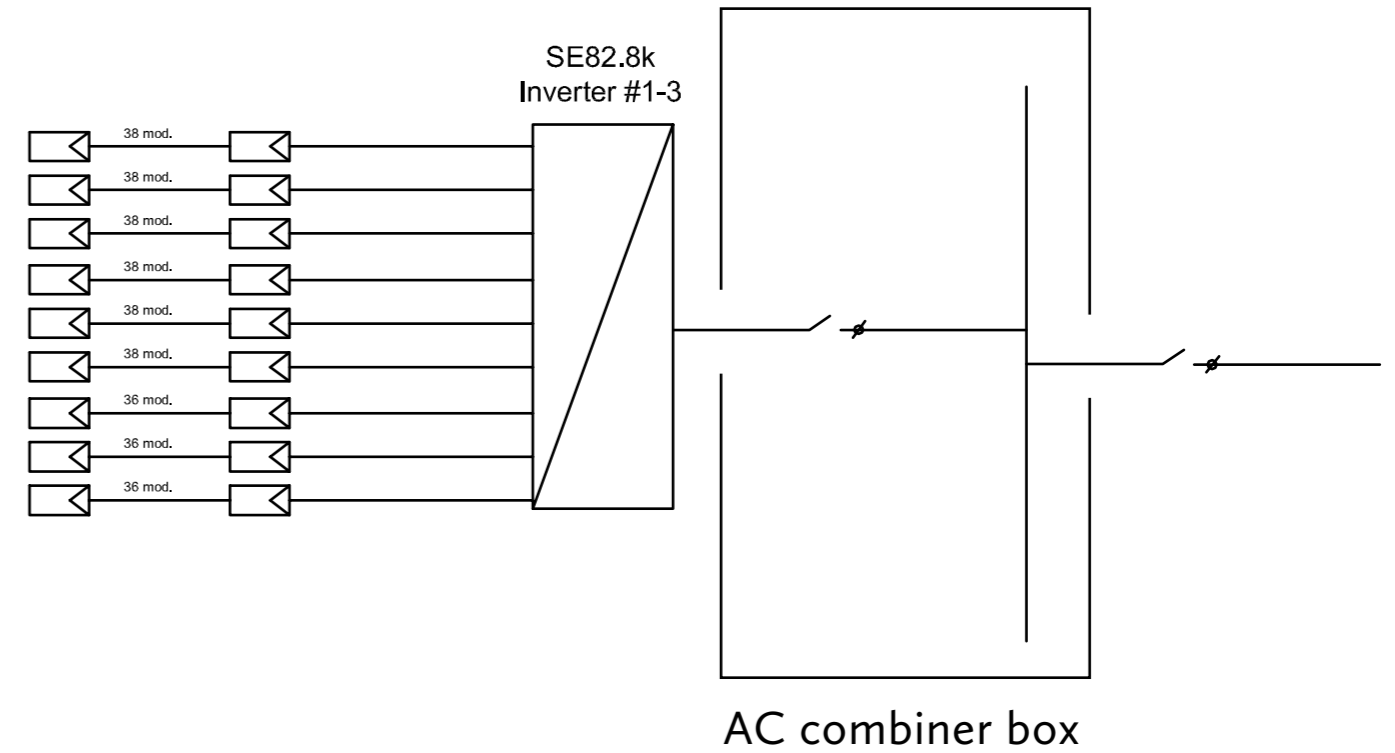

1MWp Ground Mount System Comparison

Comparison of a 1MWp SolarEdge solution to an identical system with a traditional string inverter

The system, in Munich, Germany, comprises 4,050 × 260Wp panels. One system was designed with 11 × SE82.8K SolarEdge inverters and 2,025 × P600 power optimisers in a 2:1 configuration. The second system was designed with 18 × 50kW traditional string inverters.

The SE82.8K model is a three phase inverter with synergy technology, combining large capacity with reduced installation time and cost. The inverter is based on three small and lightweight units; one primary unit easily connected to two secondary units. Up to 31 inverters can be configured directly from one master inverter for fast commissioning.

Energy comparison

PVsyst was used to simulate the yield of both systems in year 1 and year 20. The SolarEdge advantage is growing with time due to uneven panel aging which increases mismatch between panels.

	Traditional String Inverter	SolarEdge System	SolarEdge Advantage
PVsyst year 1 yield (MWh)	1,159	1,182	2%
PVsyst year 20 yield (MWh)	1,036	1,090	5.2%

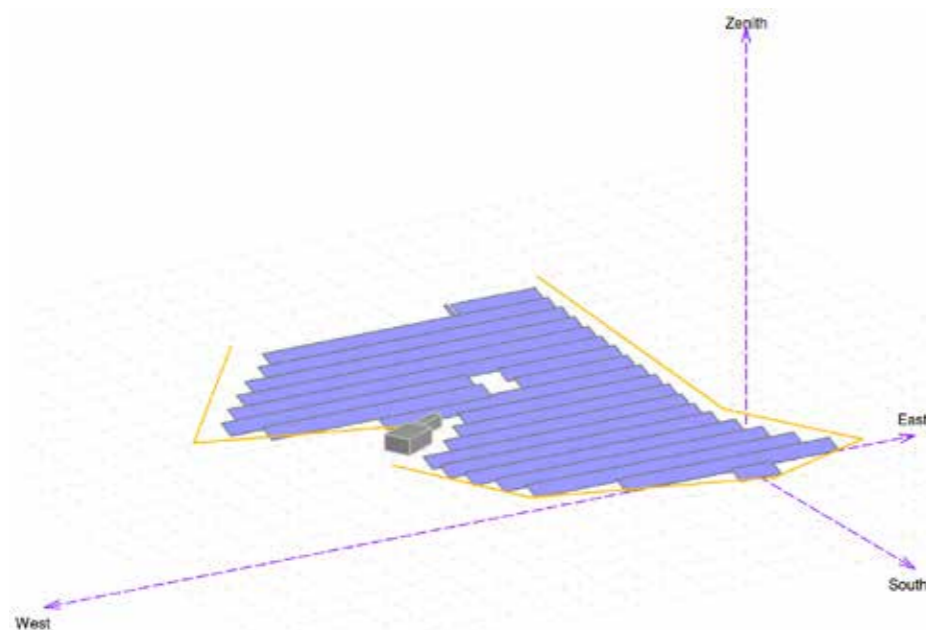

BoS comparison

	Traditional String Inverter	SolarEdge DC Optimised Inverter
DC power (kW)	1,053	1,053
AC power (kW)	900	910.8
Panels (260W, 72-cell)	4,050	4,050
Inverters	18	11
No. of strings	180	99
Panels per string	22/23	40/42
DC cable CU 1 × 6mm ² (m)	7,347	5,244
MC4 connectors (1 pair)	360	198
AC cable NA2XY 4 × 95mm ² (m)	-	747
AC cable NA2XY 4 × 70mm ² (m)	1,349	-
Datalogger	1	-
BoS cost	100%	62%
BoS cost saving*		0.4 c/w

* Estimated saving on BoS components based on typical market prices in €

Cabling comparison

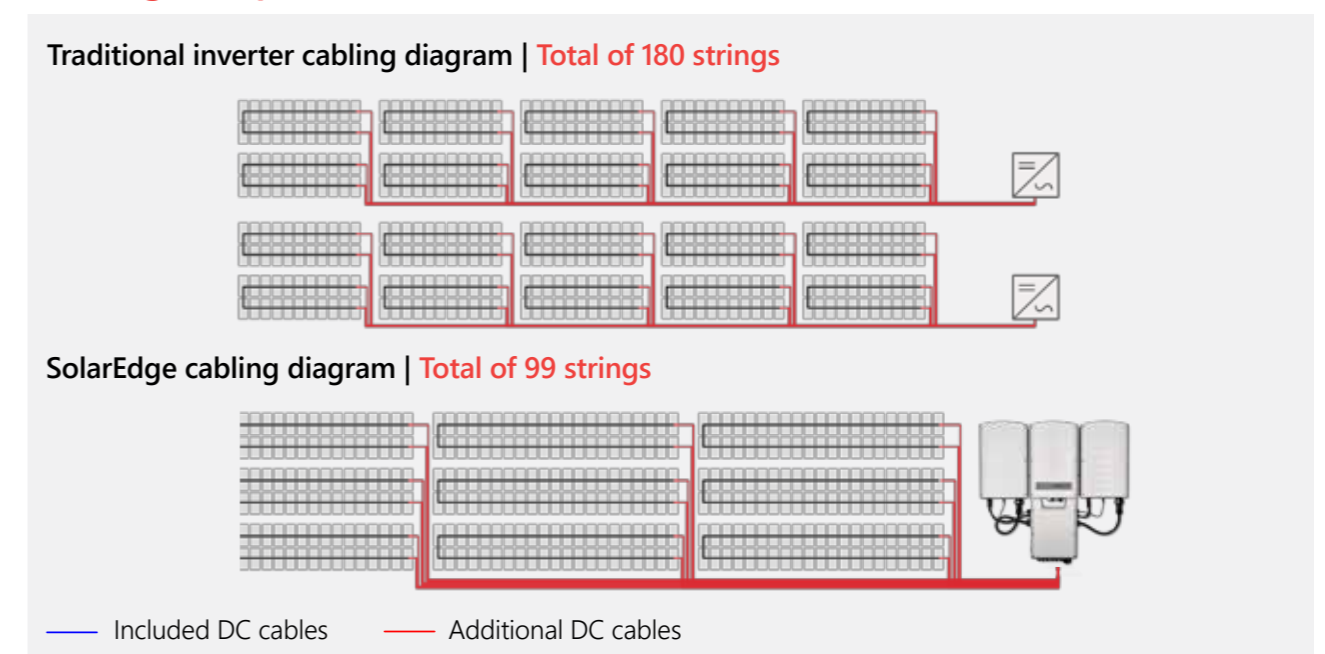

1MWp Ground Mount System — Electrical Diagram Comparison

Traditional string inverter system

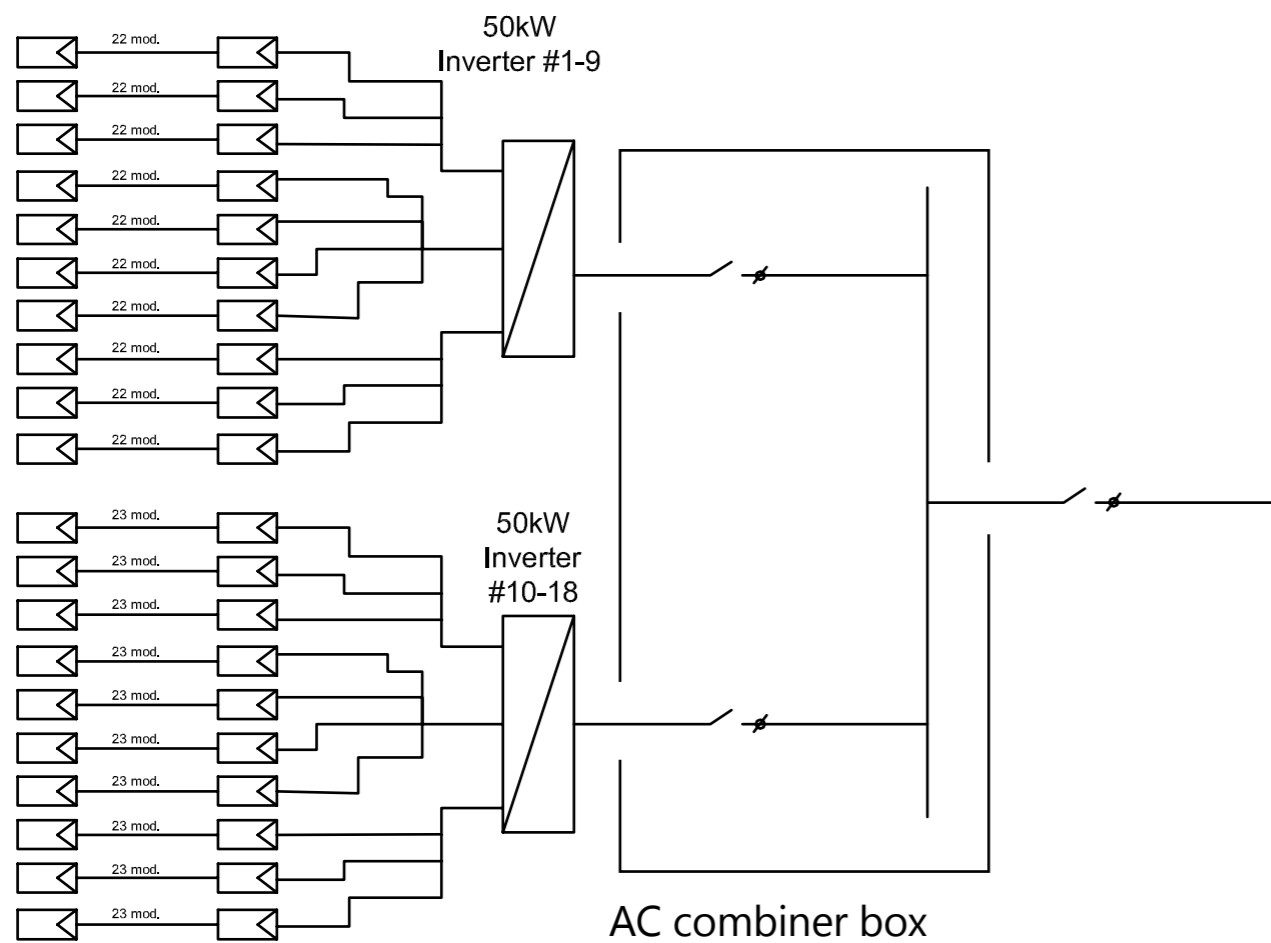

SolarEdge DC optimised inverter solution

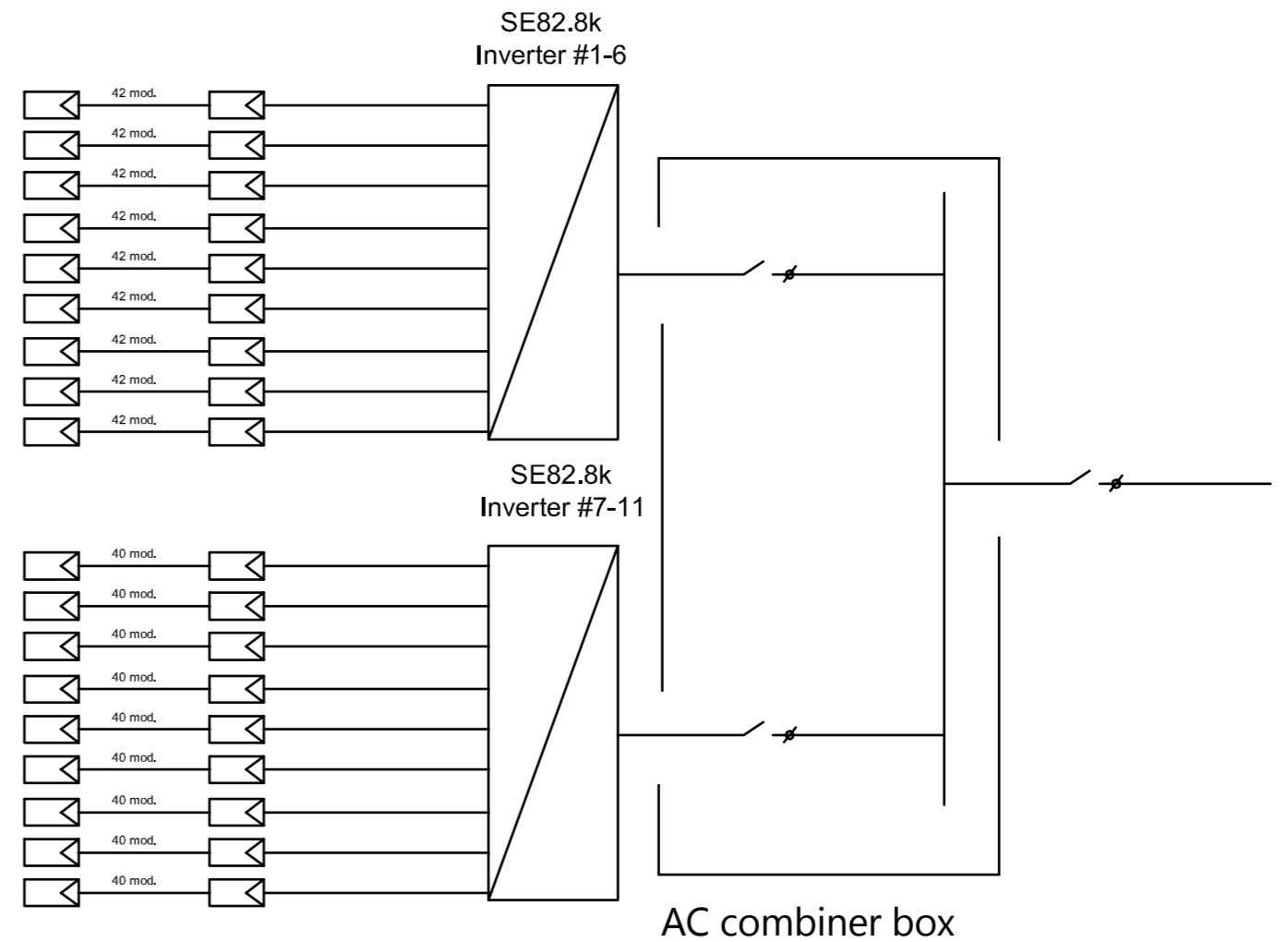



Commercial Product Offering

CLICK ONE OF THE RED ICONS TO LEARN MORE ABOUT EACH PRODUCT
To view online, scan the QR code or copy the link: solaredge.com/offering-SA



Commercial PV solution

 Movie



 Investors catalog



 Installer & EPC catalog



 System Owner brochure

Three phase inverters

12.5kW-33.3kW





 12.5kW-27.6kW datasheet



 33.3kW for MV grid datasheet

Three phase inverters with synergy technology

Combines large capacity with ease of installation
50kW-100kW





 Movie



 50kW-82.8kW datasheet

 66.6kW-100kW for MV grid datasheet

Power optimisers

Panel-level optimisation with 2:1 configuration
P600-P850





 Datasheet

Monitoring platform

Free, real-time system visibility at the panel level





 Movie

Designer

Online tool to plan, build and validate your SolarEdge systems from inception to installation





 Movie

Communication options

Multiple options for wireless connection of inverters to the internet e.g. for monitoring







 Commercial gateway datasheet



 Cellular plug-in datasheet



 Wi-Fi/ZigBee external antenna datasheet

Energy meter & current transformers

Supports high accuracy production/consumption monitoring, and export limitation









 Datasheet

Performance monitoring

Calculate site performance ratio and measure environmental conditions







 Environmental sensors datasheet

 Satellite-based PR brochure

RS485 port accessories



Enhances system safety





 SPD plug-in datasheet

Commercial Offering Ordering Information

Contact your local SolarEdge distributor for more details







Part Number	Product Description	
Three Phase Inverters; with SetApp inverter configuration; 12-year warranty included		
SE15K-ZA0T0BNN4	3ph Inverter, 15.0kW (-40 °C)	
SE16K-ZA0T0BNN4	3ph Inverter, 16.0kW (-40 °C)	
SE17K-ZA0T0BNN4	3ph Inverter, 17.0kW (-40 °C)	
SE25K-ZA000BNN4	3ph Inverter, 25.0kW (-40 °C)	
SE27.6K-ZA000BNN4	3ph Inverter, 27.6kW (-40 °C)	
SE33.3K-ZA048BNN4	3ph Inverter, 33.3kW for 277/480V Grids (-40 °C; requires medium voltage transformer)	
Three Phase Inverters; with SetApp inverter configuration; DC Safety Unit, including DC Safety Switch and DC Surge Protection (Type II); 12-year warranty included		
SE25K-ZA000BNP4	3ph Inverter, 25.0kW (-40 °C)	
SE25K-ZA000BND4	3ph Inverter, 25.0kW, with Fuses, (-40 °C)	
SE27.6K-ZA000BNP4	3ph Inverter, 27.6kW (-40 °C)	
SE27.6K-ZA000BND4	3ph Inverter, 27.6kW, with Fuses, (-40 °C)	
SE33.3K-ZA048BNP4	3ph Inverter, 33.3kW for 277/480V Grids (-40 °C; requires medium voltage transformer)	
SE33.3K-ZA048BND4	3ph Inverter, 33.3kW for 277/480V Grids, with Fuses, (-40 °C; requires medium voltage transformer)	

Part Number	Product Description		
Power Optimisers; 25-year warranty included			
P600-4RM4MRM	Designed for 60 cells, 2 in series (portrait), with 10.25Ain max, with max Vin (@ min temp) 96V, output cable length 1.2m		
P600-4RM4MRL	Designed for 60 cells, 2 in series (landscape), with 10.25Ain max, with max Vin (@ min temp) 96V, output cable length 1.8m		
P650-4RM4MRM	Designed for 60 cells, 2 in series (portrait), with 11Ain max, with max Vin (@ min temp) 96V, output cable length 1.2m		
P650-4RM4MRL	Designed for 60 cells, 2 in series (landscape), with 11Ain max, with max Vin (@ min temp) 96V, output cable length 1.8m		
P730-4RM4MRM	Designed for 72 cells, 2 in series (portrait), with max Vin (@ min temp) 125V, output cable length 1.2m		
P730-4RM4MRY	Designed for 72 cells, 2 in series (landscape), with max Vin (@ min temp) 125V, output cable length 2.2m		
P730-4RMLMRY	Designed for 72 cells, 2 in series, with max Vin (@ min temp) 125V, output cable length 2.2m, long input 0.9m (designed for panels with split junction box)		
P800P-4RMDMBM	Designed for 96 cells 5", 2 in parallel (portrait), max Vin (@ min temp) 83V, output cable length 1.2m, dual input		
P800P-4RMDMBL	Designed for 96 cells 5", 2 in parallel (landscape), max Vin (@ min temp) 83V, output cable length 1.8m, dual input		
P850-4RM4MBM	Designed for high power/bi-facial, 2 in series, max input voltage (@ min temp) 125V, output cable length 1.2m		
P850-4RM4MBY	Designed for high power/bi-facial, 2 in series, max input voltage (@ min temp) 125V, output cable length 2.2m		
P850-4RMLMBY	Designed for high power/bi-facial, 2 in series, max input voltage (@ min temp) 125V, output cable length 2.2m, long input 0.9m (designed for panels with split junction box)		
P850-4RMXMBY	Designed for high power/bi-facial, 2 in series, max input voltage (@ min temp) 125V, output cable length 2.2m, input 1.3m		
P850-4RMYMBY	Designed for high power/bi-facial, 2 in series, max input voltage (@ min temp) 125V, output cable length 2.2m, input 1.6m		
Power Optimiser Accessories			
SE-20MF-MC4-SEAL	20 Pairs of MC4 Seals for Power Optimiser Connectors		

Commercial Offering Ordering Information

Contact your local SolarEdge distributor for more details

Part Number	Product Description	
Communication Products		
SE1000-CCG-G-S1	Commercial Gateway	
SE1000-CCG-F-S1	Firefighter Gateway	
SE1000-GSM02-B	Cellular Plug-in for Inverters with SetApp Configuration	
SE-RS485-SPD3-B-K3	RS485 Surge Protection Kit for Inverters with SetApp Configuration (SE12.5K-27.6K)	
SE-ANT-ZBWIFI-KIT	Antenna Kit for ZigBee/Wi-Fi Communication (5 pcs) for Inverters with SetApp Configuration	
For inverters with a display		
SE1000-WIFI01	Wi-Fi Plug-in	
SE1000-RS485-IF	RS485 Plug-In	
SE-3PH-GSM-K2	Communication board and Cellular Plug-In Upgrade for 3ph Inverters	
SE-RS485-SPD2-K1	Surge Protection Device Plug-In for RS485 for 3ph Inverters	
Environmental Sensors		
SE1000-SEN-TAMB-S2	Ambient Temperature Sensor 0-10V	
SE1000-SEN-TMOD-S2	Panel Temperature Sensor 4-20mA	
SE1000-SEN-IRR-S1	Irradiance Sensor 0-1.4V	
SE1000-SEN-WIND-S1	Wind Velocity Sensor 4-20mA	
Warranty and service for these products is provided directly by Ingenieurbüro Mencke & Tegtmeyer GmbH. For more details, go to: http://www.imt-solar.com/products.htm		
Metering Solutions; with 5-year warranty		
SE-MTR-3Y-400V-A	1ph/3ph 230/400V, Energy Meter with Modbus Connection, DIN-Rail	
SE-RWND-3D-480-MB	480V Electricity Meter, NEMA3R, C12.20, No CT	
SE-ACT-0750-50	50A Split-Core Current Transformer, for 50Hz	
SE-CTML-0350-070	70A Split-Core Current Transformer, for 50Hz	
SE-ACT-0750-100	100A Split-Core Current Transformer, for 50Hz	
SE-ACT-0750-250	250A Split-Core Current Transformer, for 50Hz	
SE-CTS-2000-1000	1000A Split-Core Current Transformer, for 50Hz	
SE-CTB-4X4-1200	Bus-Bar CT, 4.0" x 4.0", 1200A, 1.5% acc.	
SE-CTB-4X4-2000	Bus-Bar CT, 4.0" x 4.0", 2000A, 1.5% acc.	
SE-CTB-4X4.5-3000	Bus-Bar CT, 4.0" x 4.5", 3000A, 1.5% acc.	
SE1000-SOIF01	S0 meter adapter cable	
For 50Hz grid use the 50Hz current transformers, for 60Hz grid use the 60Hz current transformers		

Part Number	Product Description	
Inverter Warranty Extensions		
Purchased within 24 months of shipment date, up to 20 years		
WE-3H-20	20 years, 3ph inverter ≥ 15kW, <25kW	
WE-3SH-20	20 years, 3ph inverter 25-33.3kW	
For 3ph inverters ≥25kW with DC Safety Unit, purchased within 24 months from shipment date		
WE-3SH-20DCD	20 years, 3ph inverter 25-33.3kW	
For 3ph inverters with synergy technology, purchased within 24 months from shipment date		
WE-3MH-20	20 years, 3ph Inverter with Synergy Technology 50-66.6kW	
WE-3UH-20	20 years, 3ph Inverter with Synergy Technology 82.8-100kW	
Monitoring Tools		
Free, real-time, panel-level monitoring of PV system performance via the SolarEdge monitoring platform. Accessible from your computer or mobile device		
For full details about the monitoring platform visit: http://www.solaredge.com/products/pv-monitoring#/		
SE-SAT-PR-S1	Satellite-based Performance Ratio; one site, for one year	
SE-SAT-PR-S2	Satellite-based Performance Ratio; one site, for one year plus one year historical data	
For full details visit: https://www.solaredge.com/products/pv-monitoring/satellite-based-pr		
Designer Tool		
A web-based tool to plan, build and validate your SolarEdge systems from inception to installation		
For full details about the Designer tool visit: https://www.solaredge.com/products/installer-tools/designer#/		
Display Products		
SE17K-EMP-B	Demo 3ph Inverter 15-33.3kW, Inverters with SetApp configuration	
SE27.6K-EMP-U-B	Demo 3ph Inverter with DC Safety Unit 25-33.3kW, Inverters with SetApp configuration	
SE55K-P-EMP-U	Demo 3ph Inverter with Synergy Technology, Primary Unit 50-66.6kW	
SE82.8K-P-EMP-U	Demo 3ph Inverter with Synergy Technology, Primary Unit 82.8-100kW	
SESU-RW-EMP	Demo 3ph Inverter with Synergy Technology, Secondary Unit	

Comprehensive Service Suite

SolarEdge supports you throughout your PV project life cycle. We provide the tools and services to help you grow your business with us.



Project design & pre-sale



Project execution



Operation & maintenance

Project design and pre-sale

Our dedicated tools and engineering services help you close deals.



Training and tools help your sales team convey the added value of the SolarEdge solution

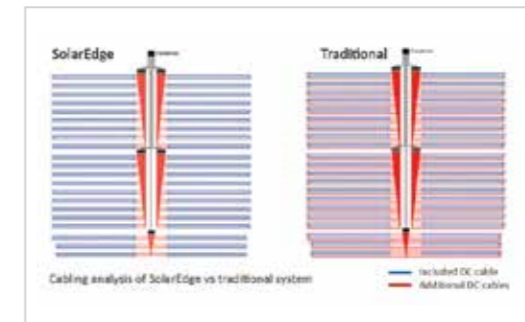

Tailor-made design optimization by SolarEdge pre-sale engineers

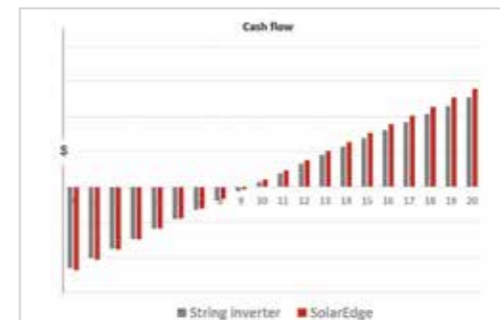

LCOE and ROI analysis

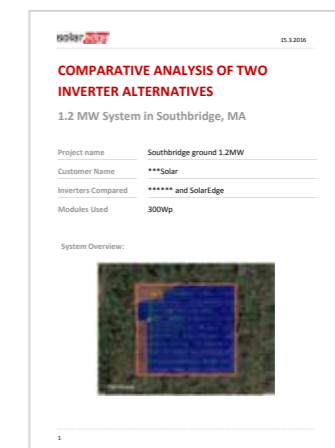

PV simulation and comparative system analysis

Comprehensive Service Suite (Cont.)

Project execution

Our advanced tools and features will assist you to easily and smoothly execute projects.



Project design validation prior to installation



Hands-on installation training by local field engineers



Installation validation checklist



DC safety protecting installers from high DC voltage



Easy and flexible string layout



Remote and on-site installation support by local service teams



Easy inverter activation and commissioning using the mobile SetApp



Remote operations to commission and activate the installation



Automatic commissioning report

Operation & maintenance

Our advanced monitoring platform allows you to guarantee system availability and high performance ratio for system lifetime.

Performance monitoring

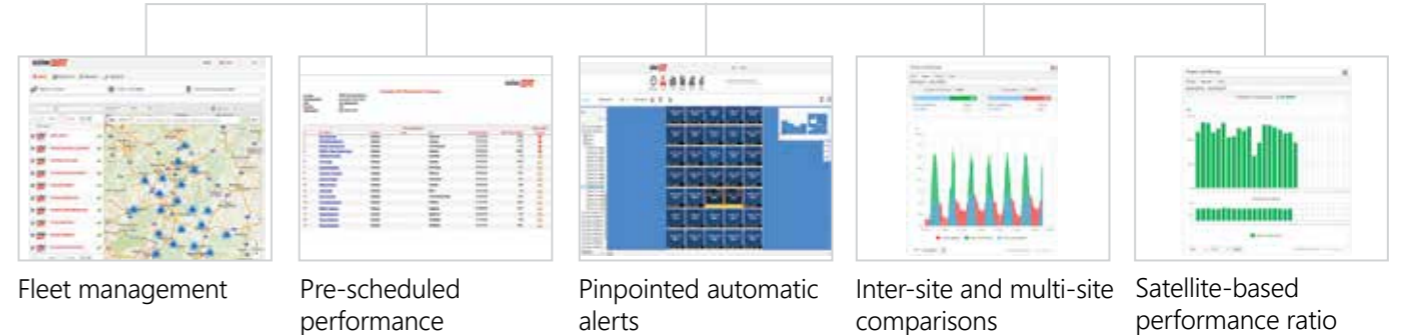

Fault detection



Service



Executive reporting









Site specific automated production reports

SolarEdge is a global leader in smart energy technology. By leveraging world-class engineering capabilities and with a relentless focus on innovation, SolarEdge creates smart energy solutions that power our lives and drive future progress.

SolarEdge developed an intelligent inverter solution that changed the way power is harvested and managed in photovoltaic (PV) systems. The SolarEdge DC optimised inverter maximises power generation while lowering the cost of energy produced by the PV system.

Continuing to advance smart energy, SolarEdge addresses a broad range of energy market segments through its PV, storage, EV charging, UPS, and grid services solutions.

-  SolarEdge
-  @SolarEdgePV
-  @SolarEdgePV
-  SolarEdgePV
-  SolarEdge
-  info@solaredge.com

solaredge.com

© SolarEdge Technologies, Inc. All rights reserved. SOLAREEDGE, the SolarEdge logo, OPTIMIZED BY SOLAREEDGE are trademarks or registered trademarks of SolarEdge Technologies, Inc. All other trademarks mentioned herein are trademarks of their respective owners. Date: 12/2019/V01/ENG SA. Subject to change without notice.

Cautionary Note Regarding Market Data and Industry Forecasts: This brochure may contain market data and industry forecasts from certain third-party sources. This information is based on industry surveys and the preparer's expertise in the industry and there can be no assurance that any such market data is accurate or that any such industry forecasts will be achieved. Although we have not independently verified the accuracy of such market data and industry forecasts, we believe that the market data is reliable and that the industry forecasts are reasonable.

The SolarEdge logo is located in the bottom right corner of the page. It features the word "solaredge" in a lowercase, sans-serif font. The "solaredge" part is white, and the "edge" part is red. The logo is positioned over a background of solar panels on a rooftop.